



STEINZEUG-KERAMO
INFOPOOL VERSION 4.0





STEINZEUG-INFOPOOL Version 4.0



Access via the Steinzeug-Keramo website: www.steinzeug-keramo.com.
Click on the Infopool icon

PERSONAL AND CONFIDENTIAL passwords for:



Name:

Username:

Password:

Enter your name, chosen username and unique password on the homepage.

Please keep these personal passwords secure and secret; passing them on to a third person is strictly prohibited!

Note: if you already have access to the Infopool, you can use these access data.

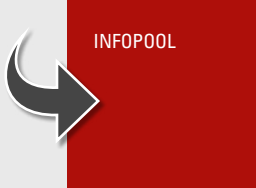

The Infopool (knowledge management system) is available to all employees in eight languages:

DE, EN, FR, NL, IT, PL, CZ, RU

INFOPOOL.

OPERATING GUIDE (BRIEF VERSION).

CONTENTS

The Infopool offers eight calculation modules, approx. 800 CAD drawings of products in our range, and also many documents on our pipes, manholes and accessories, as well as a wealth of information which describes the proper construction of wastewater installations with vitrified clay pipe systems.

OPERATION

THE FOLLOWING OVERVIEW SHOWS YOU THE BASIC FUNCTIONS OF THE INFOPOOL.

User data

In all calculation operations, the user's registration data are imported into the calculation and displayed in the header of the result printout.

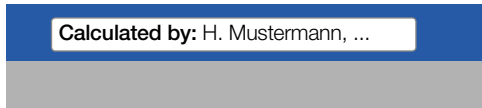

Some programmes also provide the option of entering the name of the person ordering the calculation:

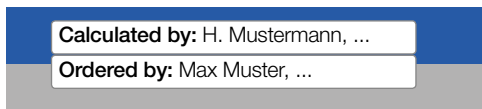

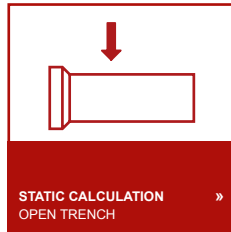

STATIC CALCULATION – OPEN TRENCH

This calculator makes it possible to check the mechanical strength of vitrified clay pipes by calculating the required bedding. The result will be a verifiable static calculation for pipes DN 100 up to DN 1000.

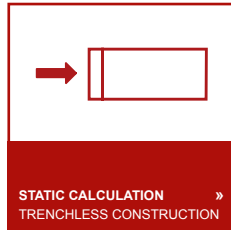

STATIC CALCULATION – TRENCHLESS CONSTRUCTION

This calculator makes it possible to draw up a static analysis for jacking pipes by calculating the permissible jacking forces. The result will be a verifiable static calculation for pipes DN 150 up to DN 1000.

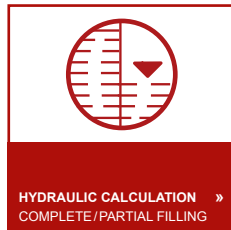

HYDRAULIC CALCULATION

This programme offers a simple method to calculate the run-off in circular profiles, thus enabling the flow rate, the gradient and the current velocity to be calculated for the products in the Steinzeug-Keramo range under full and partial filling conditions.

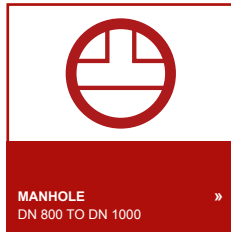

MANHOLE

Vitrified clay manholes DN 800 to DN 1000 can be designed and calculated.

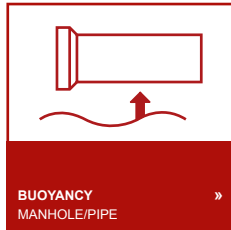

BUOYANCY

This can be used to document the exclusion of buoyancy of installations, and can be applied to both vitrified clay manholes and pipe systems.

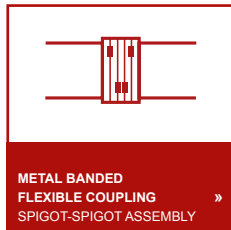

METAL BANDED FLEXIBLE COUPLING

This calculates the type of metal banded flexible coupling and, where applicable, also the number and type of the compensation elements necessary to make an effective spigot-spigot assembly.



CONNECTING SOCKET

This calculator can be used to calculate the type of connecting socket for subsequent connections with vitrified clay pipes and pipes made of other materials (concrete).



PROFITABILITY

This programme, designed to demonstrate the economic efficiency of vitrified clay pipe systems compared with wastewater pipe systems made of other materials.

INFOPOOL.

CAD DRAWINGS.

CAD drawings of our products can be downloaded in DWG, DXF and WMF formats.

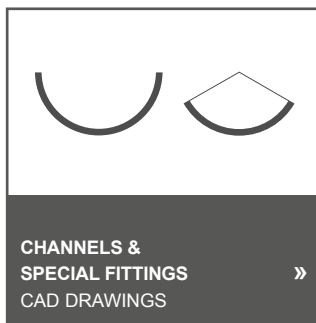
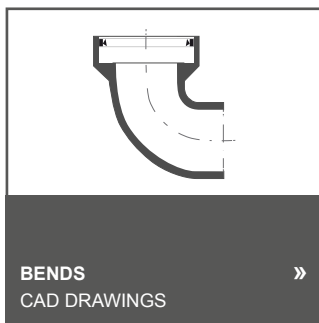
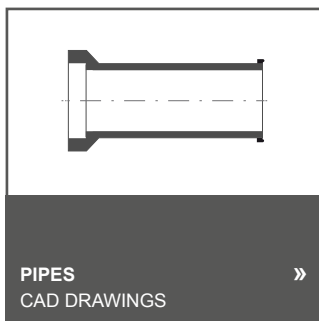

CAD SOFTWARE IS REQUIRED
TO USE THE DRAWINGS!

INFOPOOL. SEARCH.

Search routines in the Infopool are run using keywords and full text. The search term must be contained in the keyword list for the search routine to be successful. In the full-text search routine, matching character strings in the document title and text are sought out.

SEARCH-TERM AUTOCOMPLETE FUNCTION

Enter at least **three characters** of the search term in the **SEARCH** box. The corresponding search terms known in the Infopool are then displayed.

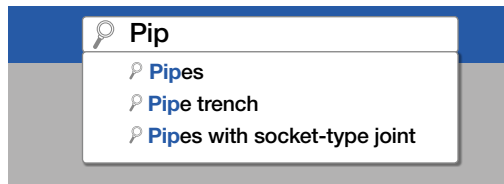

COMBINED FULL-TEXT SEARCH

Options for combined full-text search:

AND: Search term 1 blank space search term 2



OR: Search term 1 blank space **OR** blank space search term 2

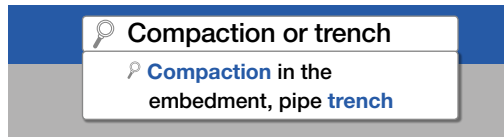

ONLY: "Search term"





DISPLAY

Documents can be opened directly from the displayed document lists by double-clicking the symbol. With the exception of tendering texts and images, Infopool documents are saved in PDF format. A PDF reader (e.g. Adobe Acrobat Reader) is required to be able to read these documents.



SAVE/PRINT

After downloading, documents can be saved, printed and sent directly from the application programme using the Acrobat Reader functionalities.

Exception: After downloading, graphics and Word documents can also be printed directly from the self-starting programmes or taken for further processing in these programmes.



LOG OUT

Click the “Log out” button to close the Infopool tool and to return to the Steinzeug-Keramo homepage. Please make it a principle to use this button every time you leave the Infopool, since this is the only way of ensuring that no one else can access your data by unauthorised use of your username and password.



Contacts

Infopool

Dietmar T. Böhme
 Phone +49 2234 507 288
 Mobile +49 172 911 9383
 Fax +49 2234 507 792 88
 E-mail d.boehme@steinzeug-keramo.com

Structural calculation:

Pascal Aengeveld
 Phone +32 11 265 228
 Mobile +32 494 561 605
 Fax +32 11 2652 43
 E-mail p.aengeveld@steinzeug-keramo.com

Gerno Mandt

Phone +49 2234 507 239
 Mobile +49 173 934 6583
 Fax +49 2234 507 792 39
 E-mail g.mandt@steinzeug-keramo.com

KCAS Team

Phone +49 2234 507-0
 Fax +49 2234 507-207
 E-mail info@steinzeug-keramo.com

Steinzeug-Keramo GmbH

Alfred-Nobel-Straße 17 | D-50226 Frechen

Phone +49 2234 507 0
 Fax +49 2234 507 207

E-mail info@steinzeug-keramo.com
 Internet www.steinzeug-keramo.com

Steinzeug-Keramo N.V.

Paalsteenstraat 36 | B-3500 Hasselt

Phone +32 11 210 232
 Fax +32 11 210 944

E-mail info@steinzeug-keramo.com
 Internet www.steinzeug-keramo.com