



THE KERA RANGE

SOLUTIONS FOR TODAY'S WASTEWATER INDUSTRY

A SOLUTION FOR WASTEWATER FROM EUROPE FOR EUROPE



3 LOCATIONS
IN EUROPE*

BRANCH OFFICES
Belgium, Germany,
France, Italy, Poland

CONTACTS
Luxembourg,
the Netherlands
Austria, Portugal, Romania,
Switzerland, Slovakia, Spain,
Czech Republic, Hungary



420
EMPLOYEES



180
YEARS

of experience in
municipal and
industrial
drainage



WORLDWIDE
2.033
KILOMETERS

The average annual quantity of
KERA pipe systems delivered



ACTIVE IN
23 countries

* Headquarters in Frechen (DE), production facilities in Bad Schmiedeberg (DE) and Hasselt (B)



Ecological. Economical. Proven.

FUTURE-ORIENTED WASTEWATER SOLUTIONS FROM STEINZEUG-KERAMO

Steinzeug-Keramo, a Wienerberger Group company, is a solutions and systems provider for the sustainable water and wastewater industry.

As a medium-sized company with many years of experience, we prove ourselves to our partners with fully developed expertise in the production, installation and operation of water and wastewater systems. At the same time, we attach great value to the high quality and sustainability of our products. Our core competency is in the production of future-proof pipe systems that are fully compliant with the highest technical, economic and ecological requirements.

We produce pipes, manholes, fittings and accessories in the highest quality, and offer entire system solutions – for safe, reliable and economical operation spanning generations.

At the same time, the range of products we offer is geared towards efficient construction site management and fulfills all the requirements of modern sewer systems. What's more, the use of natural raw materials and the application of the most modern process engineering results in extremely durable products that are fully recyclable and have a service life exceeding 100 years.



DISCOVER MORE WITH AUGMENTED REALITY!

- 1 Download the Steinzeug-Keramo AR app
- 2 Scan pages with the AR marker
- 3 Discover more!



CONTENTS

THE KERA RANGE

The right components for every job

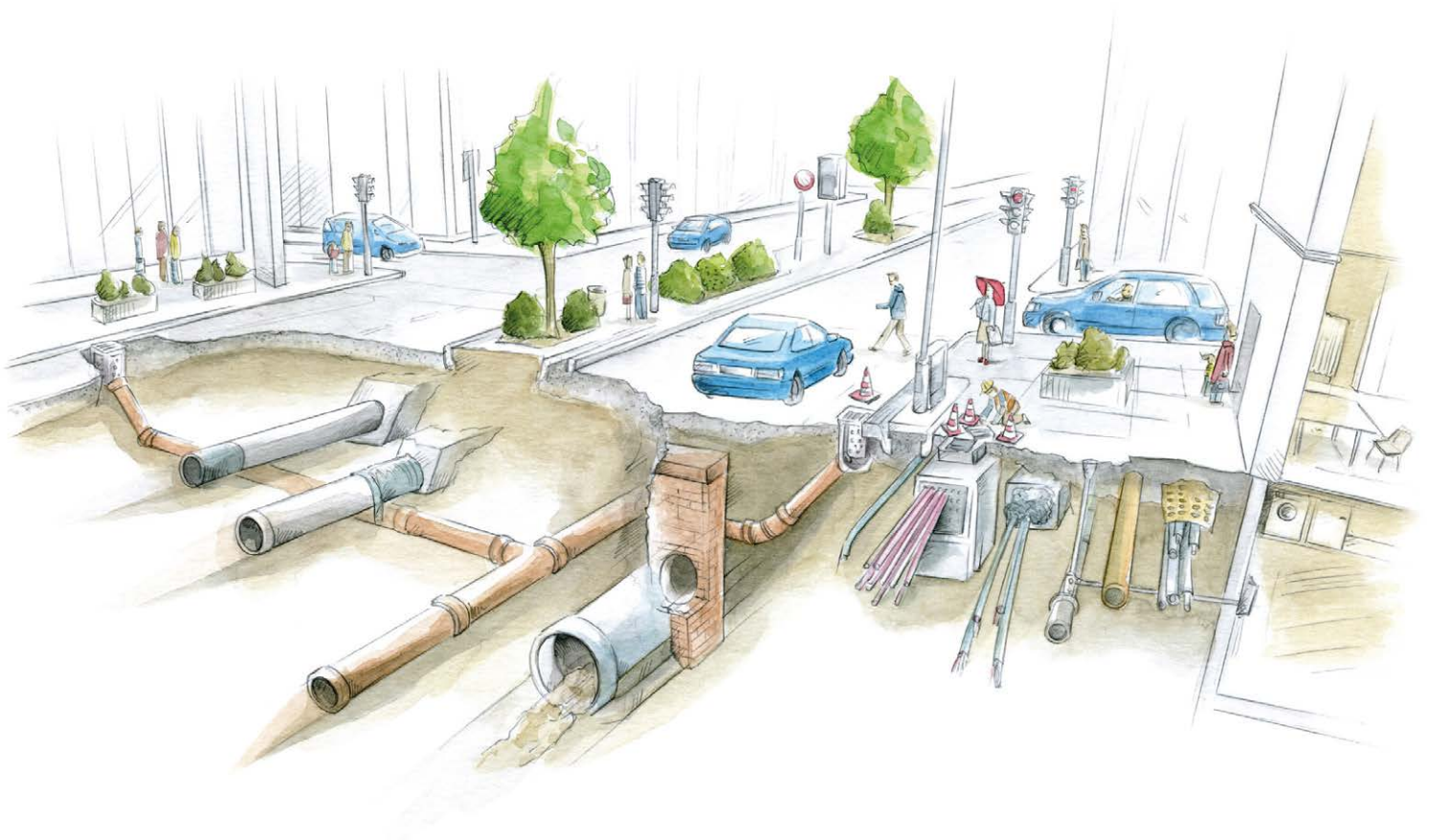

NEW

SYSTEM **iX**
CONNECTION IS EVERYTHING

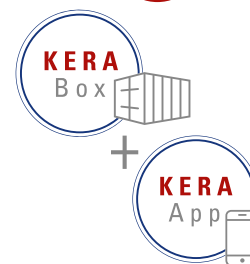

KERA.BASE/KERA.PRO OPEN-TRENCH CONSTRUCTION

Joint Systems	8
KERA.Base – Normal Strength	10
KERA.Pro – Extra Strength	20
Special Fittings	28
System.iX	36

KERA.DRIVE TRENCHLESS CONSTRUCTION

KERA.Drive – Jacking Pipes	44
Jacking Technologies	55
Renewal Methods	62
Construction Pits	64
Tests	65

KERA.PORT MANHOLES

KERA.Port Manholes	67
Construction Features	68
Product Range	74
Special Solutions	81
Installation	83

KERA.MAT ACCESSORIES

COUPLING.Pro	87
COUPLING.Basic	88
Ceramic Coupling	94
Connecting Elements	95
Joints	99
Joint Elements, Auxiliaries and Appliances	100

AT A GLANCE

Certificates	103
Standards	104
Material Properties	105
Service and Support	106

ENVIRONMENTAL PROTECTION AND SUSTAINABILITY

Responsibility in Everyday Practice	108
Cradle to Cradle®	110
Climate-Neutral Production	112

OPEN-TRENCH CONSTRUCTION

All a question of agreement

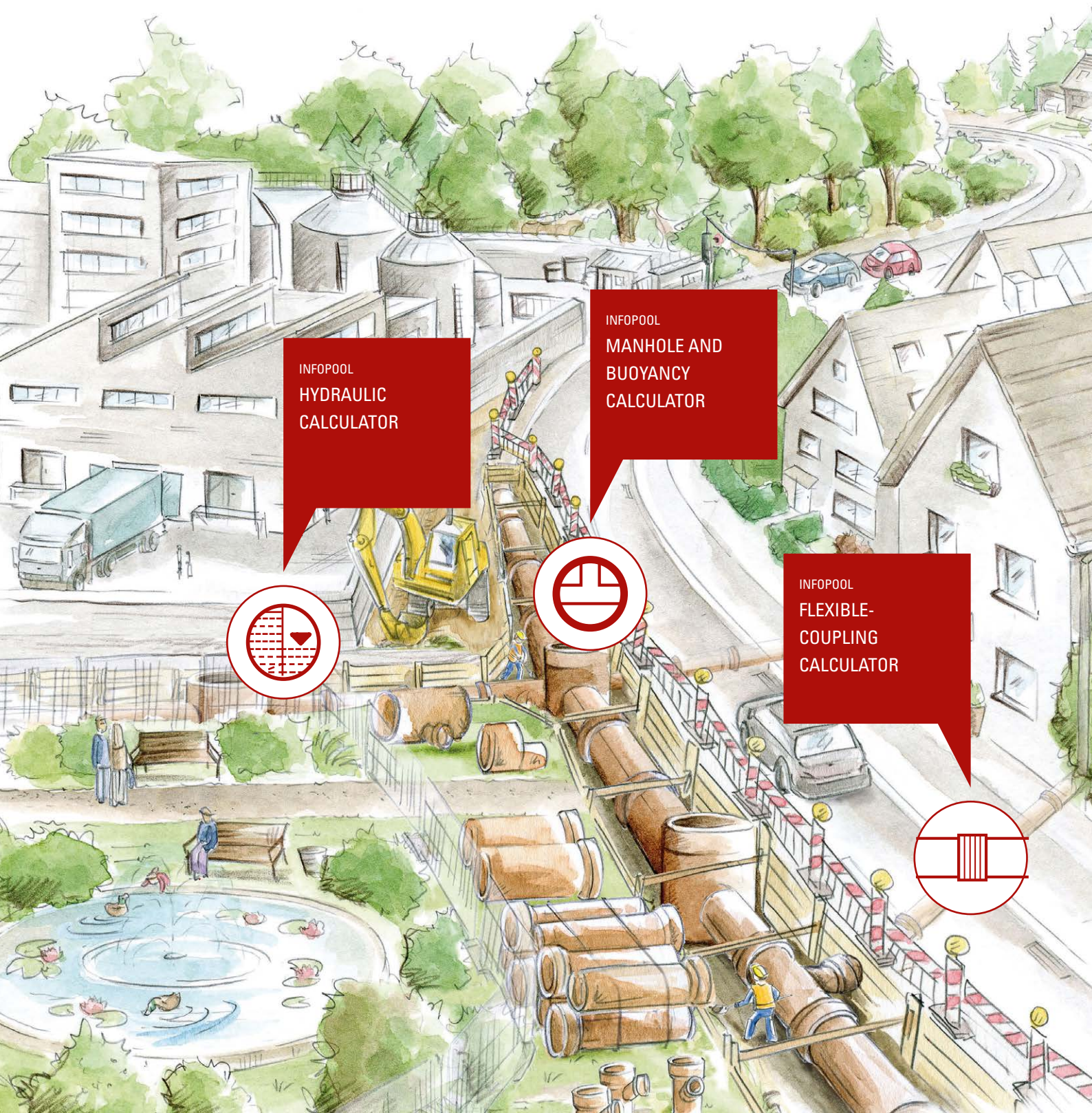

INFOPOOL
HYDRAULIC
CALCULATOR

INFOPOOL
MANHOLE AND
BUOYANCY
CALCULATOR

INFOPOOL
FLEXIBLE-
COUPLING
CALCULATOR

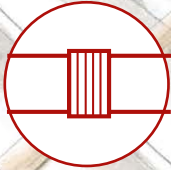

- > DEVELOPMENT OF NEW HOUSING AREAS
- > RENEWAL OF EXISTING SYSTEMS
- > HOUSE CONNECTIONS

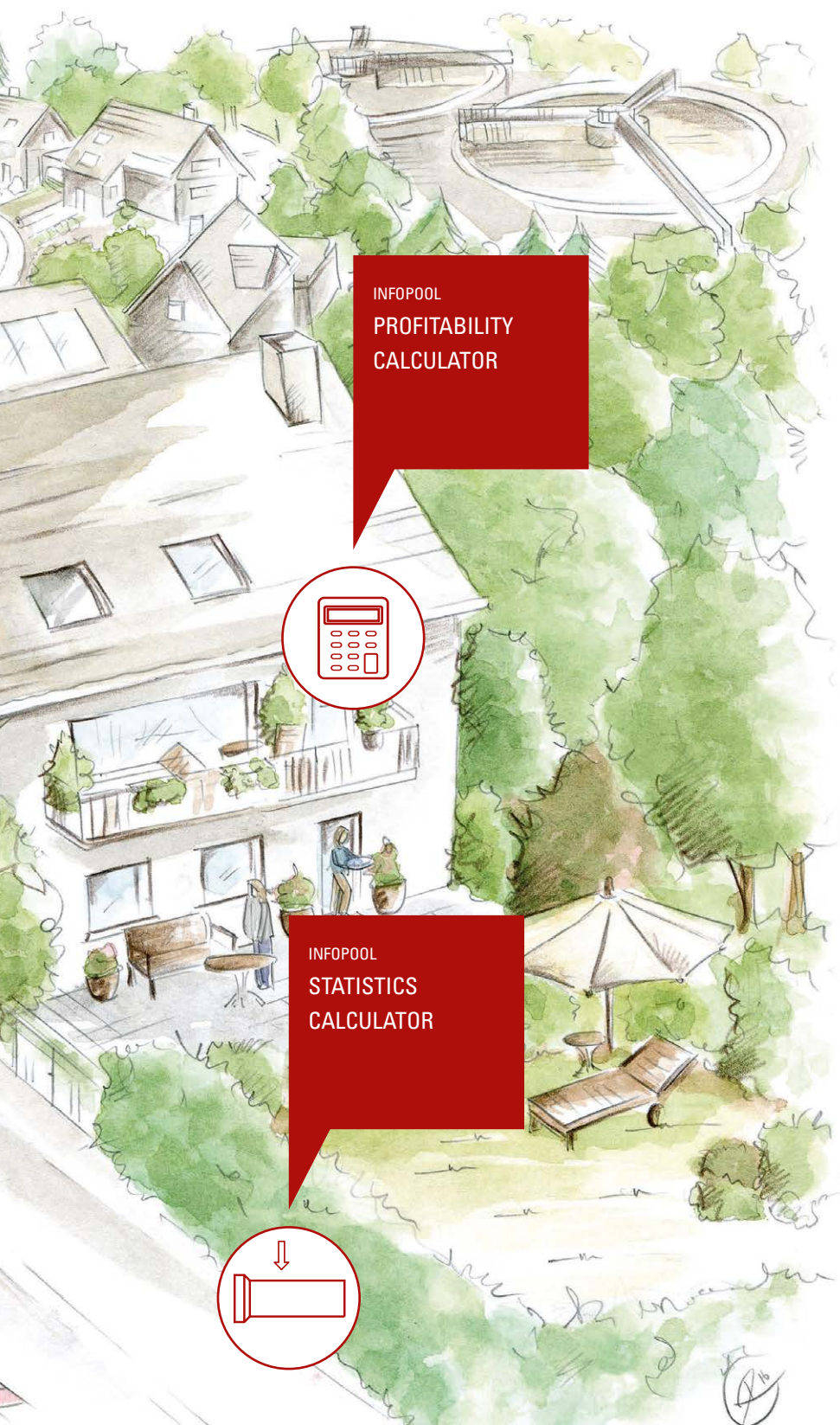
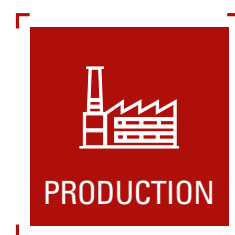

INFOPOOL
PROFITABILITY
CALCULATOR



INFOPOOL
STATISTICS
CALCULATOR

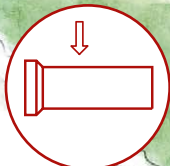

We're at your side and committed to taking care of your needs. We work with you at every stage and support you in all matters concerning sewer construction. Our competent employees around the world live this comprehensive service concept every day.

- Regional Contacts
- Personal construction-site consulting
- Online-Service

INFOPOOL

You can find our calculation modules, CAD drawings and additional detailed information and seminars in our Infopool.

JOINT SYSTEMS

FOR KERA.BASE AND KERA.PRO

L JOINT

JOINT SYSTEM F

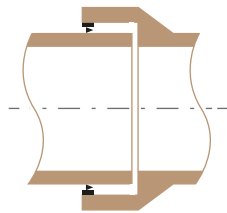

The L joint consists of a profile ring to align the spigot, and the sealing material is EPDM.

In nominal sizes DN 100 - DN 200

K JOINT

JOINT SYSTEM C

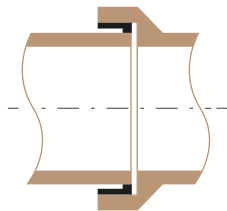

The K joint consists of a sealing element within the socket (polyurethane, rigid) and a sealing element attached to the spigot (polyurethane, soft).

In nominal sizes DN 200 - DN 800

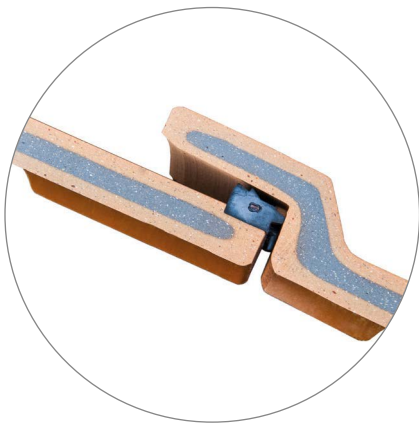

S JOINT
JOINT SYSTEM C

Pipe systems fitted with an S joint consist of a ceramic-rubber seal. After firing, the socket and the spigot are ground with high precision to the required size. An EPDM sealing ring is attached to the spigot during the manufacturing process.



In nominal sizes DN 200 - DN 600

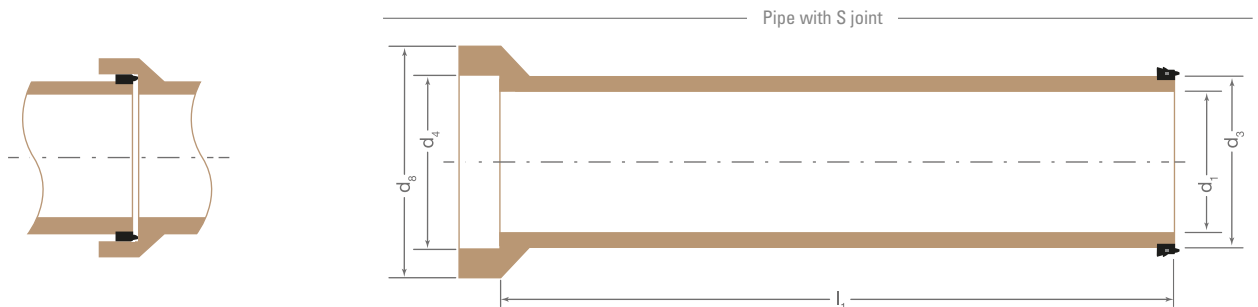

KERA.BASE

NORMAL STRENGTH

FOR USE IN ZONE II
WATER PROTECTION
AREAS:
KERA.BASE 2.4

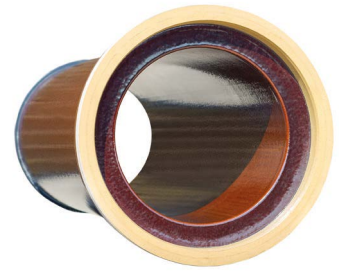

KERA.Base pipe/L joint

KERA.Base pipe/K joint

KERA.Base pipe/S joint

KERA.BASE PIPES | NORMAL STRENGTH

Nominal Size	Joint	Joint System	Pipe Diameter		Socket Diameter		Length	Weight	Crushing Strength	Strength Class
			Inner d ₁	Outer d ₃	Inner d ₄	Outer d ₈				
DN			mm	mm	mm	Max. mm	l ₁ cm	Kg/Piece	FN kN/m	
100	L	F	100 ± 4,0	131 ± 1,5	–	200	125	18	34	34
125	L	F	126 ± 4,0	159 ± 2,0	–	230	125	24	34	34
150	L	F	151 ± 5,0	186 ± 2,0	–	260	100	24	34	34
150	L	F	151 ± 5,0	186 ± 2,0	–	260	150	36	34	34
200	L	F	200 ± 5,0	242 ± 3,0	–	340	100	38	32	160
200	L	F	200 ± 5,0	242 ± 3,0	–	340	150	54	32	160
200	S	C	200 ± 5,0	242 ± 5,0	260 ± 0,5	340	250	92	40	200
250	K	C	250 ± 6,0	299 ± 6,0	317,5 ± 0,5	400	250	132	40	160
250	S	C	250 ± 6,0	299 ± 6,0	317,5 ± 0,5	400	250	132	40	160
300	K	C	300 ± 7,0	355 ± 7,0	371,5 ± 0,5	470	250	181	48	160
300	S	C	300 ± 7,0	355 ± 7,0	371,5 ± 0,5	470	250	181	48	160
350	K	C	348 ± 7,0	417 ± 7,0	433,5 ± 0,5	525	250	253	56	160
400	K	C	398 ± 8,0	486 ± 8,0	507,5 ± 0,5	620	250	350	64	160
400	S	C	398 ± 8,0	486 ± 8,0	507,5 ± 0,5	620	250	350	64	160
500	K	C	496 ± 9,0	581 ± 9,0	605 ± 0,5	730	250	435	60	120
500	S	C	496 ± 9,0	581 ± 9,0	605 ± 0,5	730	250	435	60	120
600	K	C	597 ± 12,0	687 ± 12,0	720 ± 0,5	860	250	575	57	95
600	S	C	597 ± 12,0	687 ± 12,0	720 ± 0,5	860	250	575	57	95

Other lengths available on request



KERA.Base Bend 15°



KERA.Base Bend 30°



KERA.Base Bend 90°

KERA.BASE BENDS | NORMAL STRENGTH

BEND 15° WITH
K JOINT

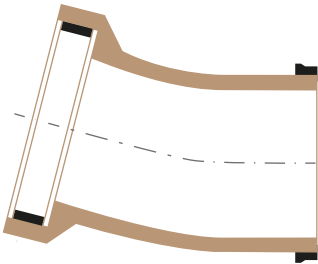

BEND 90° WITH
L JOINT

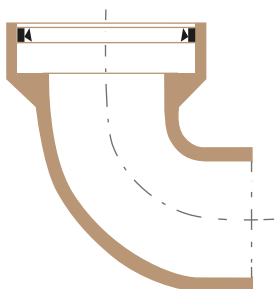

Nominal Size	Specification	Joint	Joint System	Weight	Strength Class
DN	Angle*			Kg/Piece	
100	15°	L	F	6	34
100	30°	L	F	6	34
100	45°	L	F	6	34
100	90°	L	F	6	34
125	15°	L	F	7	34
125	30°	L	F	7	34
125	45°	L	F	7	34
125	90°	L	F	7	34
150	15°	L	F	10	34
150	30°	L	F	10	34
150	45°	L	F	10	34
150	90°	L	F	10	34
200	15°	L	F	15	200
200	30°	L	F	15	200
200	45°	L	F	15	200
200	90°	L	F	15	200
200	15°	K	C	15	200
200	30°	K	C	15	200
200	45°	K	C	15	200
200	90°	K	C	15	200
250	15°	K	C	25	160
250	30°	K	C	25	160
250	45°	K	C	25	160
300	15°	K	C	37	160
300	30°	K	C	37	160
300	45°	K	C	37	160

* 15° ± 3°; 30° ± 4°; 45° ± 5°; 90° ± 5°



KERA.Base Junction 45°

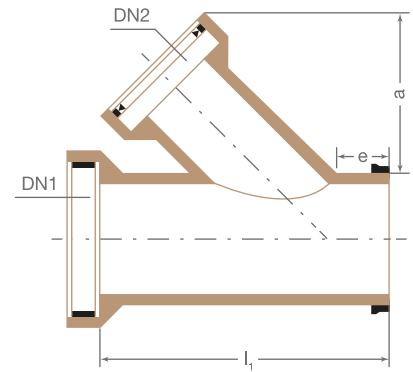

Junction 45°

KERA.BASE JUNCTIONS 45° | NORMAL STRENGTH

Nominal Size	Specification	Branch Size	Joint	Joint System	Dimensions		Length	Weight	Strength Class
					e Min.	a Max.			
DN 1	Angle	DN 2	DN 1 DN 2	DN 1 DN 2	mm	mm	l ₁ cm	Kg/Piece	DN1/ DN2
	± 5°								
100	45°	100	LL	FF	70	240	40	12	34/34
125	45°	100	LL	FF	70	240	40	15	34/34
125	45°	125	LL	FF	70	260	40	15	34/34
150	45°	100	LL	FF	75	240	40	16	34/34
150	45°	125	LL	FF	75	260	40	18	34/34
150	45°	150	LL	FF	75	270	50	20	34/34
200	45°	150	KL	CF	85	350	50	32	200/34
200	45°	200	KK	CC	85	370	60	40	200/200
200	45°	150	LL	FF	85	270	50	32	200/34
200	45°	200	LL	FF	85	370	60	40	200/200
250	45°	150	KL	CF	85	350	50	41	160/34
250	45°	200	KL	CF	85	370	60	48	160/200
250	45°	200	KK	CC	85	370	60	48	160/200
300	45°	150	KL	CF	85	350	50	49	160/34
300	45°	200	KK	CC	85	370	60	60	160/200
300	45°	200	KL	CF	85	370	60	60	160/200





KERA.Base Junction 90°

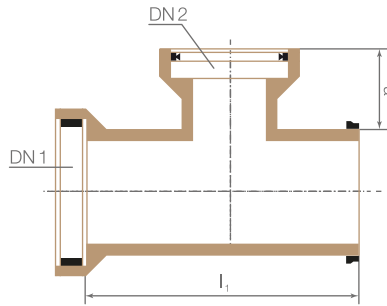

Junction 90°

KERA.BASE JUNCTION 90° | NORMAL STRENGTH

Nominal Size	Specification	Branch Size	Joint	Joint System	Dimensions	Length	Weight	Strength Class
DN 1	Angle	DN 2	DN 1 DN 2	DN 1 DN 2	a Max. mm	l ₁ cm	Kg/Piece	DN1/DN2
	± 5°							
125	90°	125	LL	FF	160	40	15	34/34
150	90°	150	LL	FF	160	50	18	34/34
200	90°	150	KL	CF	170	60	32	200/34
200	90°	200	KK	CC	180	60	40	200/200
200	90°	150	LL	FF	170	50	32	200/34
200	90°	200	LL	FF	180	60	40	200/200
250	90°	150	KL	CF	170	50	41	160/34
250	90°	200	KL	CF	180	60	48	160/200
250	90°	200	KK	CC	180	60	48	160/200
300	90°	150	KL	CF	170	50	49	160/34
300	90°	200	KL	CF	200	60	60	160/200
300	90°	200	KK	CC	200	60	60	160/200



KERA.Base Junction without socket



KERA.Base compact junction

KERA.BASE JUNCTIONS WITHOUT SOCKETS 45° | NORMAL STRENGTH

Nominal Size	Specification	Branch Size	Joint	Joint System	Dimensions		Length	Weight	Strength Class
					a Max.	e			
DN 1	Angle	DN 2	DN 2	DN 2	mm	mm	cm	Kg/Piece	DN1/DN2
	± 5°								
150	45°	150	L	F	270	75	50	17	34/34
200	45°	150	L	F	305	85	60	25	200/34
250	45°	150	L	F	300	85	60	34	160/34
300	45°	150	L	F	300	85	60	42	160/34

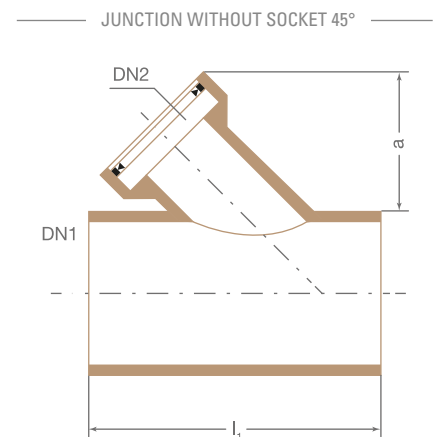

KERA.BASE COMPACT JUNCTION 90° | NORMAL STRENGTH

Nominal Size	Specification	Branch Size	Joint	Joint System	Dimensions	Length	Weight	Strength Class
DN 1	Angle	DN 2	DN 1 DN 2	DN 1 DN 2	mm	cm	Kg/Piece	DN1/DN2
	± 5°	mm	cm					
350	90°	150	KL	CF	70	75	53	160/34
350	90°	200	KL	CF	80	75	53	160/200
400	90°	150	KL	CF	70	75	109	160/34
400	90°	200	KL	CF	80	75	109	160/200
500	90°	150	KL	CF	70	75	143	120/34
500	90°	200	KL	CF	80	75	143	120/200
600	90°	150	KL	CF	70	75	194	95/34
600	90°	200	KL	CF	80	75	194	95/200

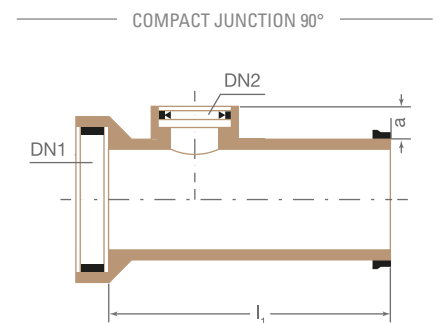



KERA.Base connector GE



KERA.Base auxiliary connector

KERA.BASE CONNECTORS GE | NORMAL STRENGTH

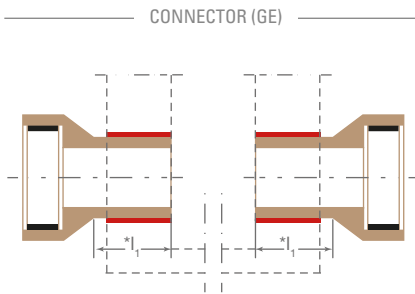

* l₁ Installation outer dimension

Nominal Size	Joint	Joint System	Length	Weight	Strength Class
DN			l ₁ cm	Kg/Piece	
150	L	F	25	10	34
200	K	C	25	14	200
200	L	F	25	14	200
250	K	C	25	20	160
300	K	C	25	31	160
350	K	C	25	37	160
400	K	C	25	61	160
500	K	C	25	84	120
600	K	C	25	118	95

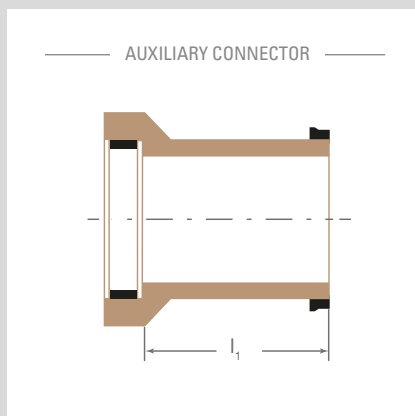

KERA.BASE AUXILIARY CONNECTORS FOR CONNECTING DIFFERENT STRENGTH CLASSES

Auxiliary connector N on H, spigot N, socket H. For the transition between extra strength and normal strength ranges (for identical nominal sizes), the following adapters are available: DN 200 H/200 N and DN 250 H/250 N. Socket sizes are for the extra strength range (H), and spigot sizes are for the normal strength range (N). Length is 0.25 m (± 10 mm).



KERA.Base Inlet connector



KERA.Base outlet connector

KERA.BASE INLET CONNECTORS | NORMAL STRENGTH

Nominal Size	Joint	Joint System	Length	Weight	Crushing Strength	Strength Class
DN			l_1		FN	
			cm	Kg/Piece	kN/m	
150	L	F	60	19	34	34
200	K	C	60	25	40	200
200	L	F	60	25	40	200
250	K	C	60	41	40	160
300	K	C	60	56	48	160
350	K	C	75	83	56	160
400	K	C	75	115	64	160
500	K	C	75	146	60	120
600	K	C	75	197	57	95

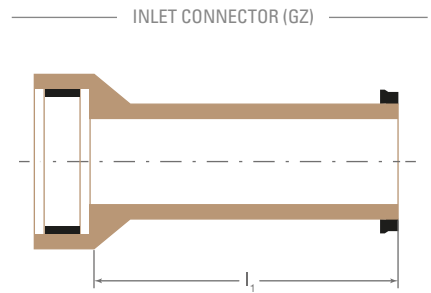

KERA.BASE OUTLET CONNECTORS | NORMAL STRENGTH

Nominal Size	Joint	Joint System	Length	Weight	Crushing Strength	Strength Class
DN			l_1		FN	
			cm	Kg/Piece	kN/m	
150	L	F	60	16	34	34
200	K	C	60	24	40	200
200	L	F	60	24	40	200
250	K	C	60	34	40	160
300	K	C	60	45	48	160
350	K	C	75	71	56	160
400	K	C	75	95	64	160
500	K	C	75	117	60	120
600	K	C	75	160	57	95

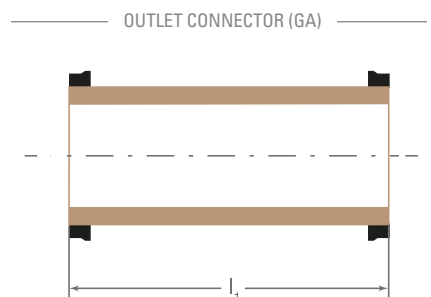



KERA.Base End cap



KERA.Base Transition section

KERA.BASE END CAPS | NORMAL STRENGTH

END CAP K JOINT

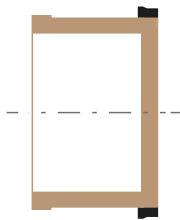

Nominal Size	Joint	Joint System	Weight	Strength Class
DN				
100	L	F	Kg/Piece	34
125	L	F	2	34
150	L	F	3	34
200	K	C	4	200
200	L	F	4	200
250	K	C	5	160
300	K	C	6	160
400	K	C	15	160

Additional accessories e.g. fixing hooks, also available on request

KERA.BASE TRANSITION SECTIONS | NORMAL STRENGTH

TRANSITION SECTION

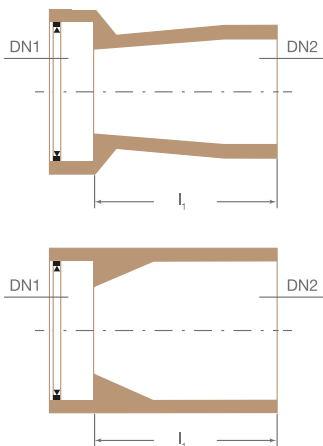

Nominal Size		Joint	Joint System	Length	Weight	Strength Class
DN 1	DN 2			l ₁		
				cm	Kg/Piece	DN 1/DN 2
100	125	L	F	25	6	34/34
100	150	L	F	25	7	34/34
125	150	L	F	25	8	34/34
150	200	L	F	25	11	34/200
150	200	LK	FC	25	11	34/200
200	250	KK	CC	25	15	200/160
200	250	LK	FC	25	15	200/160
250	300	KK	CC	25	21	160/160



KERA.Base 1/2 section channel



KERA.Base 1/3 section channel

KERA.BASE 1/2 SECTION CHANNEL | NORMAL STRENGTH

Nominal Size	Chord Length	Wall Thickness	Length	Weight
DN	b_1	l_1		
	mm	mm	cm	Kg/Piece
150	152 +/- 3	19 +/-2	100 +/- 2	10
200	200 +/- 3	22 +/-2	100 +/- 2	15
250	250 +/- 4	22 +/-2	100 +/- 2	24
300	300 +/- 5	27 +/-2	100 +/- 2	31
350	350 +/-6	27 +/-2	100 +/- 2	38
400	400 +8/-4	29 +/-2	100 +/- 2	48
500	500 +9/-5	34 +/-2	100 +/- 2	65
600	600 +12/-8	48 +/-2	100 +/- 2	104

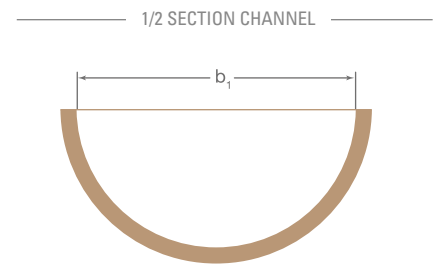

KERA.BASE 1/3 SECTION CHANNEL | NORMAL STRENGTH

Nominal Size	Chord Length	Wall Thickness	Length	Weight
DN	b_1	l_1		
	mm	mm	cm	Kg/Piece
250	217 +4/-1	21 +/-2	50 +/- 0,5	6
300	260 +5/-2	27 +/-2	50 +/- 0,5	9
400	350 +5/-3	29 +/-2	50 +/- 0,5	14
500	430 +6/-3	34 +/-2	50 +/- 0,5	25
600	517 +8/-5	48 +/-2	50 +/- 0,5	27

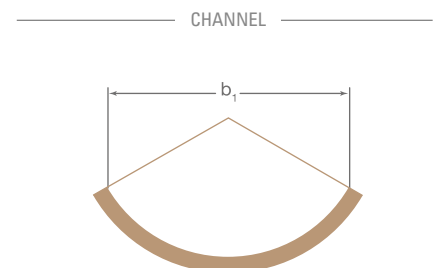

KERA.PRO

EXTRA STRENGTH

FOR USE IN
WATER PROTECTION
AREAS ZONE II:
KERA.PRO 2.4



KERA.Pro Pipe/Joint K

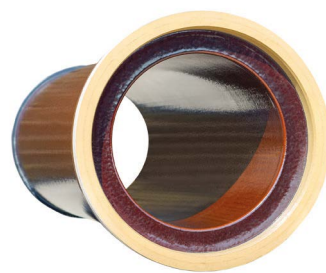

KERA.Pro Pipe/Joint S

KERA.PRO PIPES | EXTRA STRENGTH

Nominal Size	Joint	Joint System	Pipe Diameter		Socket Diameter		Length	Weight	Crushing Strength	Strength Class
			Inner d ₁	Outer d ₃	Inner d ₄	Outer d ₈ Max.				
			mm	mm	mm	mm				
200	S	C	200 ± 5,0	254 ± 5,0	275 ± 0,5	360	250	107	48	240
250	S	C	250 ± 6,0	318 ± 6,0	341,5 ± 0,5	440	250	188	60	240
250	K	C	250 ± 6,0	318 ± 6,0	341,5 ± 0,5	440	250	188	60	240
300	K	C	300 ± 7,0	376 ± 7,0	398,5 ± 0,5	510	250	250	72	240
300	S	C	300 ± 7,0	376 ± 7,0	398,5 ± 0,5	510	250	250	72	240
400	K	C	398 ± 8,0	492 ± 8,0	515,5 ± 0,5	650	250	379	80	200
400	S	C	398 ± 8,0	492 ± 8,0	515,5 ± 0,5	650	250	379	80	200
500	K	C	496 ± 9,0	609 ± 9,0	637 ± 0,5	790	250	575	80	160
500	S	C	496 ± 9,0	609 ± 9,0	637 ± 0,5	790	250	575	80	160
600	K	C	597 ± 12,0	725 ± 12,0	758 ± 0,5	930	250	780	96	160
600	S	C	597 ± 12,0	725 ± 12,0	758 ± 0,5	930	250	780	96	160
700	K	C	694 ± 12,0	832 ± 12,0	871 ± 0,5	1030	200	810	112	120
800	K	C	792 ± 12,0	932 ± 12,0	976 ± 0,5	1150	200	950	96	120



KERA.Pro Bend 15°



KERA.Pro Bend 30°



KERA.Pro Junction 45°

KERA.PRO BEND | EXTRA STRENGTH

Nominal Size	Specification	Joint	Joint System	Weight	Strength Class
DN	Angle			Kg/Piece	
200	15° ± 3°	K	C	22	240
200	30° ± 4°	K	C	22	240
200	45° ± 5°	K	C	22	240
250	15° ± 3°	K	C	45	240
250	30° ± 4°	K	C	45	240
250	45° ± 5°	K	C	45	240
300	15° ± 3°	K	C	59	240
300	30° ± 4°	K	C	59	240
300	45° ± 5°	K	C	59	240

BEND 15° WITH JOINT K

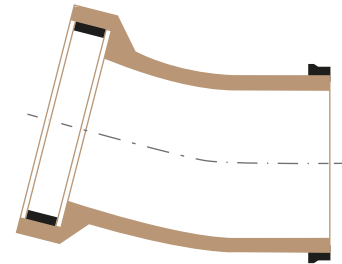

KERA.PRO JUNCTION 45° | EXTRA STRENGTH

Nominal Size	Specification	Branch size	Joint	Joint System	Dimensions	Length	Weight	Strength Class
DN 1	Angle	DN 2	DN 1 DN 2	DN 1 DN 2	e Min. Max.	a	l ₁	DN1/DN2
± 5°					mm mm	cm	Kg/Piece	
200	45°	150	KL	CF	85 305	50	36	240/34
200	45°	200	KL	CF	85 350	60	42	240/200
200	45°	200	KK	CC	85 350	60	42	240/200
250	45°	150	KL	CF	85 300	50	55	240/34
250	45°	200	KK	CC	85 350	60	64	240/200
250	45°	200	KL	CF	85 350	60	64	240/200
300	45°	150	KL	CF	85 300	50	73	240/34
300	45°	200	KK	CC	85 350	60	86	240/200
300	45°	200	KL	CF	85 350	60	86	240/200

JUNCTION 45°

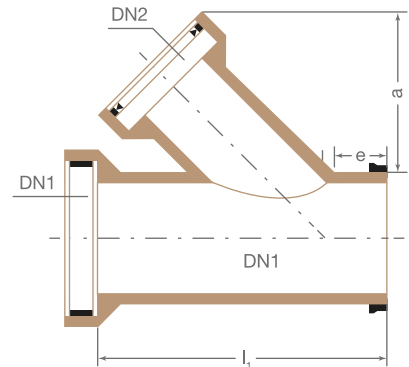



KERA.Pro Junction 90°



KERA.Pro Junction without socket 45°

KERA.PRO JUNCTION 90° | EXTRA STRENGTH

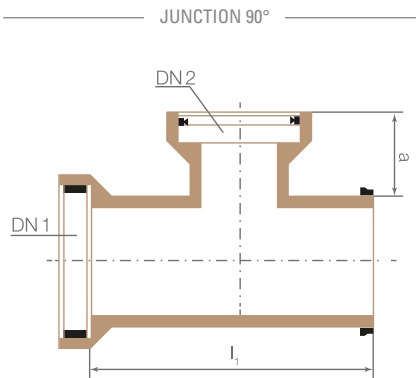

Nominal Size	Specification	Branch Size	Joint	Joint System	Dimensions	Length	Weight	Strength Class
DN 1	Angle	DN 2	DN 1 DN 2	DN 1 DN 2	a Max.	l ₁	Kg/Piece	DN1/DN2
	± 5°				mm	cm		
200	90°	150	KL	CF	170	50	36	240/34
200	90°	200	KL	CF	180	60	42	240/200
200	90°	200	KK	CC	180	60	42	240/200
250	90°	150	KL	CF	170	50	55	240/34
250	90°	200	KL	CF	180	60	64	240/200
250	90°	200	KK	CC	180	60	64	240/200
300	90°	150	KL	CF	170	50	73	240/34
300	90°	200	KK	CC	200	60	86	240/200
300	90°	200	KL	CF	200	60	86	240/200

KERA.PRO JUNCTION WITHOUT SOCKET 45° | EXTRA STRENGTH

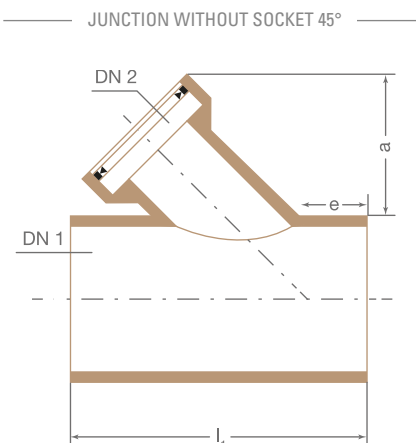

Nominal Size	Specification	Branch Size	Joint	Joint System	Dimensions	Length	Weight	Strength Class
DN 1	Angle	DN 2	DN 2	DN 2	e Min. Max.	a	l ₁	DN1/DN2
	± 5°				mm	mm	cm	Kg/Piece
200	45°	150	L	F	85 305	60	29	240/34
250	45°	150	L	F	85 300	60	55	240/34



KERA.Pro Compact Junction

KERA.Pro End cap

KERA.PRO COMPACT JUNCTION 90° | EXTRA STRENGTH

Nominal size	Specification	Branch Size	Joint	Joint System	Dimensions	Length	Weight	Strength Class
DN 1	Angle	DN 2	DN 1 DN 2	DN 1 DN 2	a Max.	l ₁	Kg/Piece	DN 1/DN 2
	± 5°				mm	cm		
400	90°	150	KL	CF	70	75	129	200/34
400	90°	200	KL	CF	70	75	129	200/34
500	90°	150	KL	CF	80	75	203	160/34
500	90°	200	KL	CF	80	75	203	160/34
600	90°	150	KL	CF	70	75	270	160/34
600	90°	200	KL	CF	70	75	270	160/34
700*	90°	150	KL	CF	80	75	335	120/34
800*	90°	150	KL	CF	70	75	395	120/34

* Special components will be produced on request

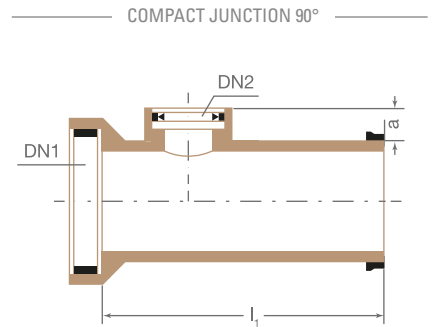

KERA.PRO END CAPS | EXTRA STRENGTH

Nominal size	Joint	Joint system	Weight	Strength class
DN				
200	K	C	8	240
250	K	C	12	240
300	K	C	14	240
400	K	C	24	200

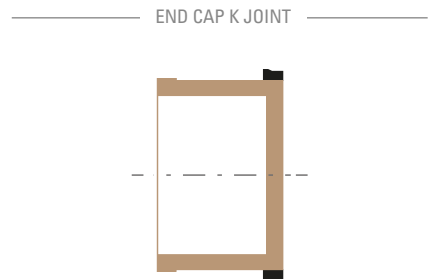



KERA.Pro Connector GE

CONNECTOR (GE)

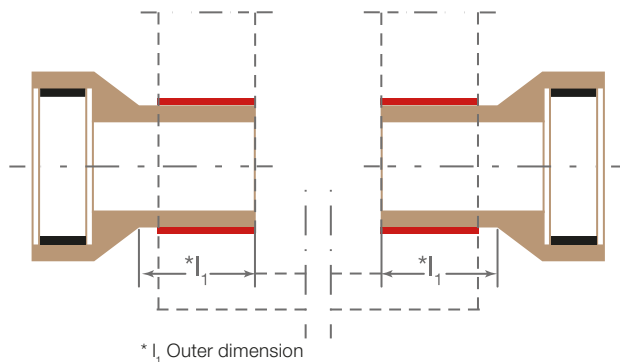

KERA.PRO CONNECTORS GE | EXTRA STRENGTH

Nominal Size	Joint	Joint System	Length	Weight	Strength Class
DN			I ₁ cm	Kg/Piece	
200	K	C	25	21	240
250	K	C	25	35	240
300	K	C	25	46	240
400	K	C	25	67	200
500	K	C	25	123	160
600	K	C	25	176	160
700	K	C	25	185	120
800	K	C	25	215	120



KERA.Pro Inlet connector



KERA.Pro Outlet connector

KERA.PRO INLET CONNECTOR | EXTRA STRENGTH

Nominal Size	Joint	Joint System	Length	Weight	Crushing Strength	Strength Class
DN			l_1 cm	Kg/Piece	FN kN/m	
200	K	C	60	36	48	240
250	K	C	60	65	60	240
300	K	C	60	84	72	240
400	K	C	75	128	80	200
500	K	C	75	208	80	160
600	K	C	75	279	96	160
700	K	C	75	335	112	120
800	K	C	75	395	96	120

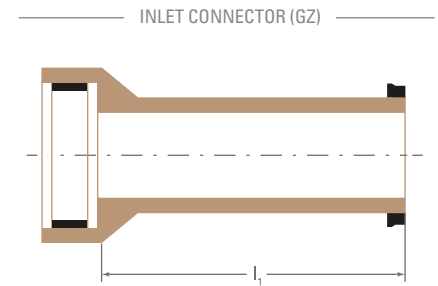

KERA.PRO OUTLET CONNECTOR | EXTRA STRENGTH

Nominal Size	Joint	Joint System	Length	Weight	Crushing Strength	Strength Class
DN			l_1 cm	Kg/Piece	FN kN/m	
200	K	C	60	31	48	240
250	K	C	60	48	60	240
300	K	C	60	66	72	240
400	K	C	75	111	80	200
500	K	C	75	163	80	160
600	K	C	75	214	96	160
700	K	C	75	285	112	120
800	K	C	75	335	96	120

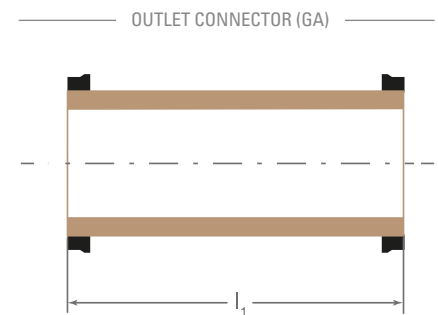



INSTALLATION

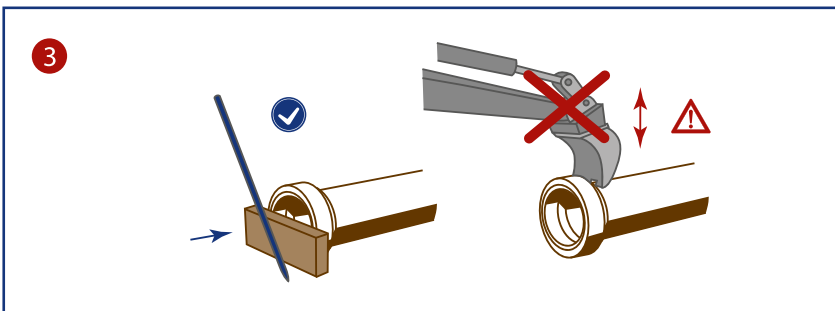
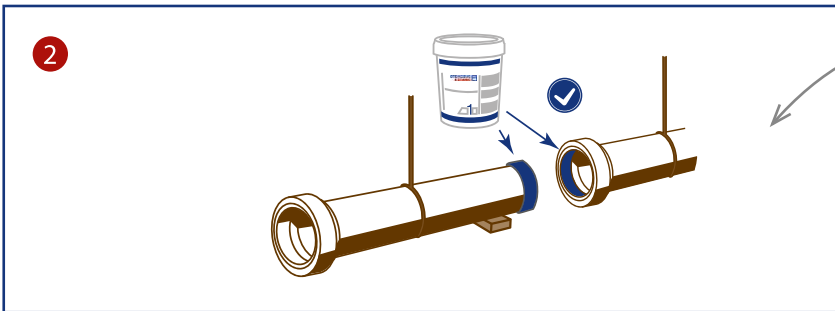
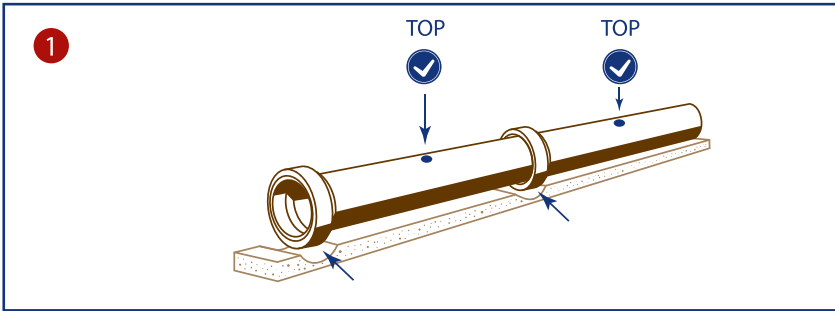

EXISTING SYSTEM RENEWAL

FITTINGS FOR SPECIAL APPLICATIONS

For complicated, exceptional situations when installing new pipes or exchanging old ones, you will find customized solutions to suit your individual needs at Steinzeug-Keramo: fittings, connecting pipes with or without socket, eccentric junctions and transition sections that can handle any connection scenario. Eccentric junctions and level-invert junctions represent solutions for special situations in sewer construction. This applies to both new installations and sewer replacement.



INDIVIDUAL SOLUTIONS

- Fittings with socket/socketless
- Inlet connection with socket/socketless
- Strength class according to standards
- Variable inlet diameters
- Variable connection invert level to meet customer needs
- Connection solutions for every kind of raw material



Socketless junction 90°, branch with socket, invert-level



Transition section DN 300/DN 500



Special junction 90° DN 1 and DN 2 with socket > DN 200

*High-precision solutions
for your project*

ECENTRIC JUNCTIONS

When replacing wastewater sewers that are no longer hydraulically adequate with larger-diameter pipes, the household connection points remain in place. If retrofitted connections or incorrectly executed connections with low inflow to the main sewage pipe exist, these can be replaced using eccentric (repair) junctions without sockets. Such situations call for connection solutions capable of flexible application, and that allow precious "height" to be gained.

For situations like this, we offer custom-made, high-precision fittings with diameters from DN 250 to DN 800 with inlet connections of DN 150/200/250, depending on diameter. Larger diameters for special cases can also be manufactured if necessary. Depending on the customer's request, a 45 ° or 90 ° version is possible.

The junctions can be finished in four versions with different "e" values, with connecting pipes available both with and without socket. For socket junctions, differentiation into right and left junctions (relative to direction of flow) has to be taken into account.

Joint system inlet

connections with socket:

DN 150 L-joint (system F) / DN 200 L-joint or K-joint (system C)/ from DN 250 K-joint

Inlet load classes:

From DN 200, inlets are available in both normal or extra strength versions. Inlet connection options: with corresponding adapters/ couplings, house connections covering a variety of materials that can be connected.

SOCKETLESS JUNCTION

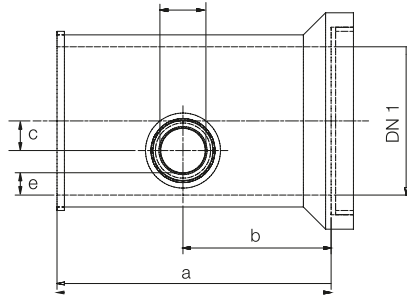

Repair junction 90°, branch with socket, invert-level

ECCENTRIC JUNCTIONS

DN 1	FN kN/m (N/H)	Strength Class	DN 2	a cm	b cm
250	40 (N)	160	150	60	30
250	60 (H)	240	150	60	30
300	48 (N)	160	150/200	60	30
300	72 (H)	240	150/200	60	30
350	56 (N)	160	150/200	75	37,5
400	64 (N)	160	150/200/250	75	37,5
400	80 (H)	200	150/200/250	75	37,5
500	60 (N)	120	150/200/250	75	37,5
500	80 (H)	160	150/200/250	75	37,5
600	57 (N)	95	150/200/250	75	37,5
600	96 (H)	160	150/200/250	75	37,5
700	112 (H)	120	150/200/250	100	50
800	96 (H)	120	150/200/250	100	50

Dimensions are to be specified on request by the customer (dimensions c and e)

DESIGN: MAIN PIPE WITH SOCKET/INLET WITH SOCKET

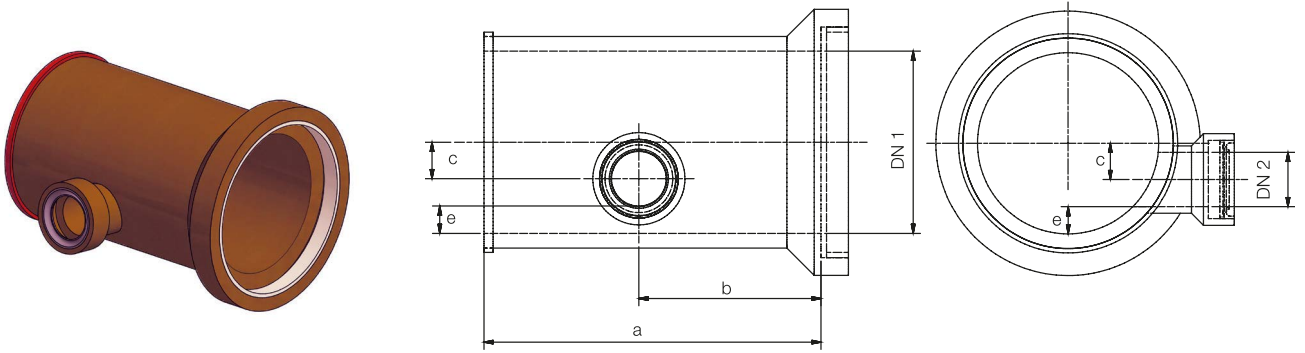

DESIGN: MAIN PIPE WITH SOCKET/INLET SOCKETLESS

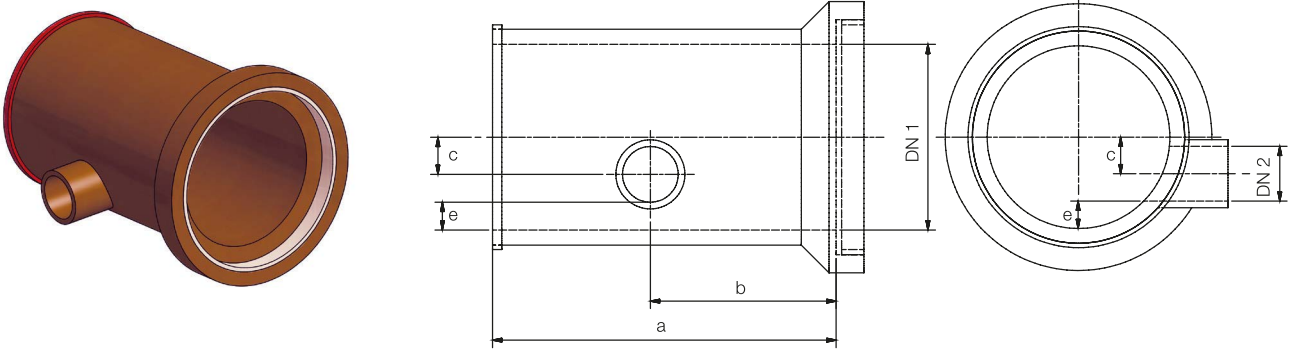

DESIGN: MAIN PIPE SOCKETLESS/INLET WITH SOCKET

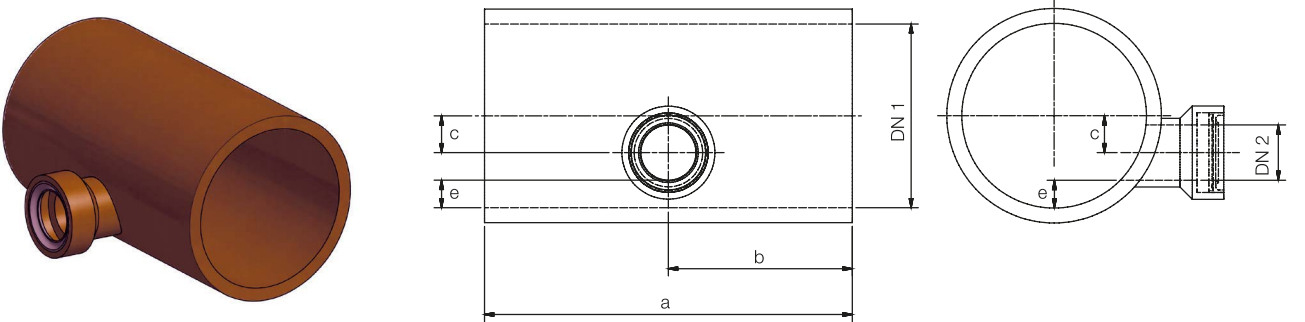

DESIGN: MAIN PIPE SOCKETLESS/INLET SOCKETLESS

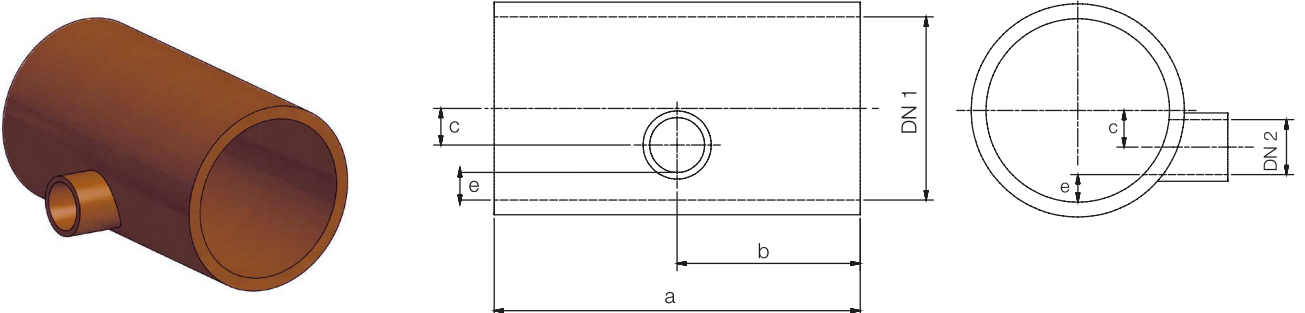



Transition section DN 300/DN 500

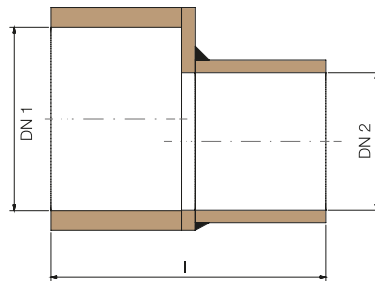

Longitudinal section

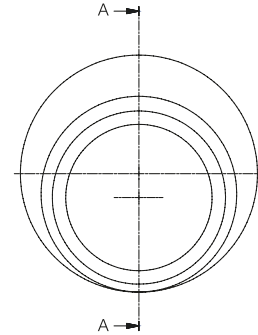

View

ECENTRIC TRANSITION SECTIONS

DN 1 mm	DN 2 mm
200	150
250	150
250	200
300	200
300	250
350	250
400	250
350	300
400	300
500	300
400	350
500	350
500	400
600	400

For special applications, we offer our customers eccentric transition sections in addition to concentric ones. Invert-level design is possible for many diameter combinations, and pipe extensions and reductions are also an option. Eccentric transition sections are manufactured when ordered, to meet specific customer requirements, making transition sections possible for many applications. For inner-city reconstructions, for example, an older, existing drain can be connected to a manhole with a changed diameter as an interim solution. Another example would be larger diameter drains which can be set up as a wastewater reservoir with reduced outflow.

The difference in diameter can be freely chosen by the customer (see table). Please talk to our experts about your special requirements. The necessary designs will be manufactured in the required load class (see table). As a rule, socketless fittings are connected to the different pipe diameters with flexible couplings. With a combination of couplings and compensation rings, these transitions are also possible for other pipes. A solution with integrated joints using joint system C is also possible.



Special junction 90° DN 1 and DN 2
with socket > DN 200

SPECIAL JUNCTIONS

Special junctions make wastewater networks as a system extremely flexible and capable. We can supply every conceivable combination in all diameters up to DN 800 at short notice. At the same time, we take into account various junction angles and loads affecting the pipe. Both the main and connecting pipes can be produced in normal and extra strength versions.

Our standard range is extended with products specially tailored to meet customer needs. If you have special requirements that go beyond the range of junctions we already provide, then talk to us. We offer a wealth of experience in specially designed sections and can manufacture them with the highest precision for your project.



You can find all our forms at:
www.steinzeug-keramo.com

SPECIAL JUNCTION 90°
DN 1 SOCKETLESS, DN 2 WITH SOCKET

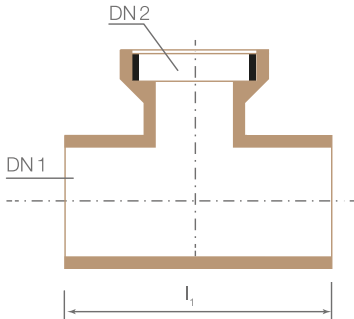

SPECIAL JUNCTION 90°
DN 1 UND DN 2 WITH SOCKET

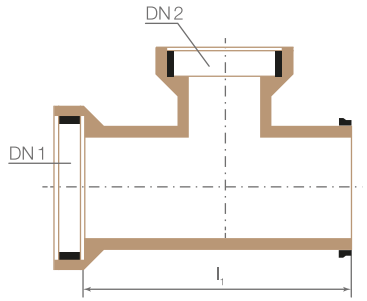

SPECIAL JUNCTIONS COMBINATIONS FOR 45° AND 90°

DIN 1 NORMAL STRENGTH DN 250 – DN 600, DN 2 NORMAL STRENGTH DN 250 – DN 600*

DN 1	DN 2	DN 2	DN 2	DN 2	DN 2	DN 2
250	250	–	–	–	–	–
300	250	300	–	–	–	–
350	250	300	350	–	–	–
400	250	300	350	400	–	–
500	250	300	350	400	500	–
600	250	300	350	400	500	600

* Combinations with DN1 normal strength – DN2 extra strength are also possible

SPECIAL JUNCTIONS COMBINATIONS FOR 45° AND 90°

DN 1 NORMAL STRENGTH DN 250 – DN 600, DN 2 NORMAL STRENGTH DN 250 – DN 600

DN 1	DN 2	DN 2	DN 2	DN 2	DN 2	DN 2
250	25	–	–	–	–	–
300	250	30	–	–	–	–
400	250	300	350	400	–	–
500	250	300	350	400	500	–
600	250	300	350	400	500	600
700	250	300	350	400	500	600
800	250	300	350	400	500	600

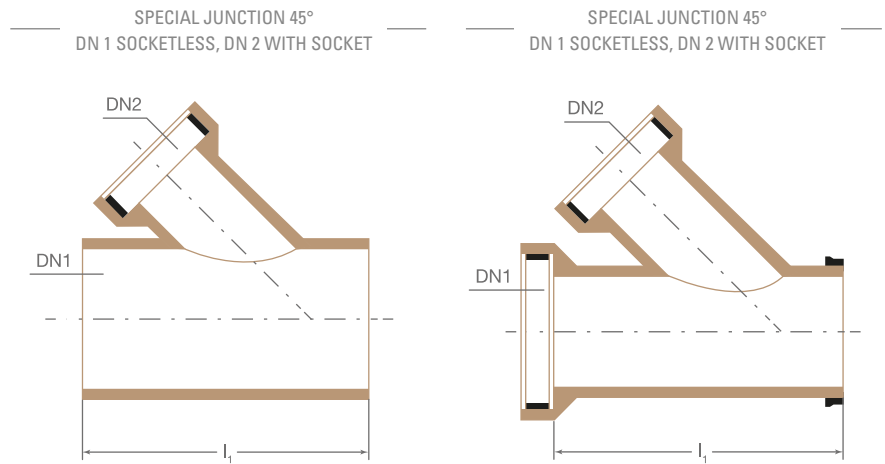

SPECIAL JUNCTIONS COMBINATIONS FOR 45° AND 90°
 DN 1 HOCHLAST DN 250 – DN 800, DN 2 HOCHLAST DN 500 – DN 800

DN 1	DN 2	DN 2	DN 2	DN 2	DN 2	DN 2	DN 2
250	250	-	-	-	-	-	-
300	250	300	-	-	-	-	-
400	250	300	400	-	-	-	-
500	250	300	400	500	-	-	-
600	250	300	400	500	600	-	-
700	250	300	400	500	600	700	-
800	250	300	400	500	600	700	800

SYSTEM

CONNECTION IS EVERYTHING



Complex sewer construction projects put the highest demands on the conditions surrounding the materials and systems used. The System.iX, with its new products, gives you the flexibility you need on your construction site. With the newly developed socketless KERA.iXP and KERA.iX vitrified clay pipes and the innovative iX.LINK connection technology perfectly matched to it, we are setting new standards in terms of simple, fast and safe installation.

NEW 
**KERA.iXH is now
also available
for house
connections.**

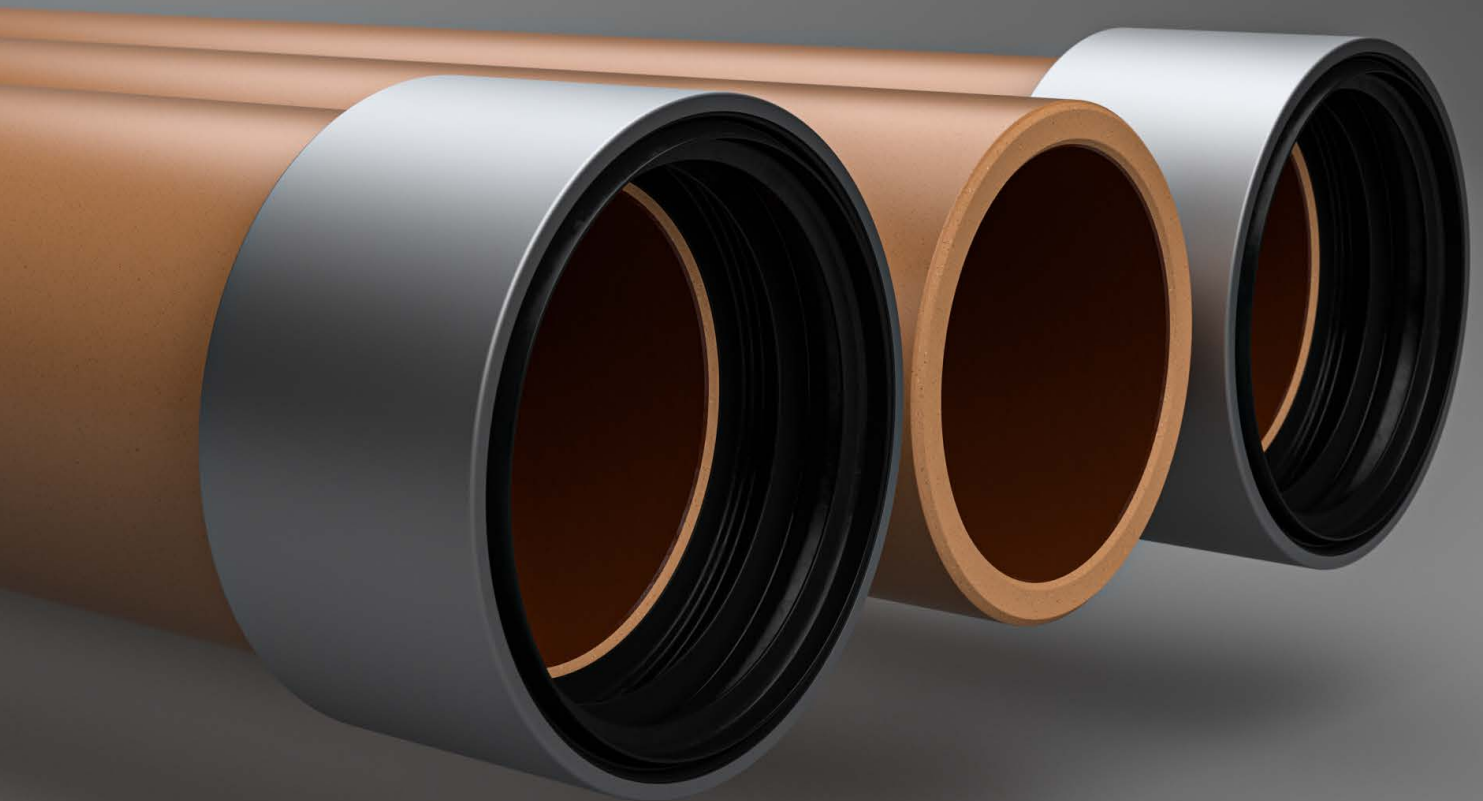



Socketless KERA.iXP pipe



iX.LINK connector



Developed for the greatest possible flexibility

FOR OPTIMAL RESULT KERA.iXP AND iX.LINK

The new KERA.iXP socketless vitrified clay pipe is exceptionally robust. Even in tight environments, it is easy and safe to install.

For our customers, it represents a universal pipe of the very highest quality. With strength class 240, it is also suitable for use with extreme loads.

KERA.iXP comes factory-fitted with the iX.LINK, enabling efficient installation with low insertion forces as well as trouble-free on-site length adjustment. KERA.iXP will be available in a universal-strength version in sizes DN 200, 250 und 300.

Together with iX.LINK, KERA.iXP offers optimized:

- **Ease of installation**
- **Robustness**
- **Tightness**



*Designed for
efficient installation*

ALWAYS PERFECTLY CONNECTED iX.LINK MAKES IT POSSIBLE

An important component of our new KERA.iX System is the customized iX.LINK connection system. It consists of a sealing element and a support element made of different materials. The connection is factory-fitted firmly to one end of the KERA.iX pipe, allowing for quick and easy installation on site, with low insertion forces and maximum freedom of movement in the trench. Its innovative construction guarantees a controlled socket joint and complete resistance against root ingress. It is also compatible with our existing KERA products. The

combination options with pipes of different strengths and diameters, as well as with connecting elements from different requirement classes, offer solutions for practically every project.

Exactly the right element, every time: For different requirements, connecting elements are available in Basic, Standard and Pro versions.

SYSTEM **iX** CONNECTION IS EVERYTHING

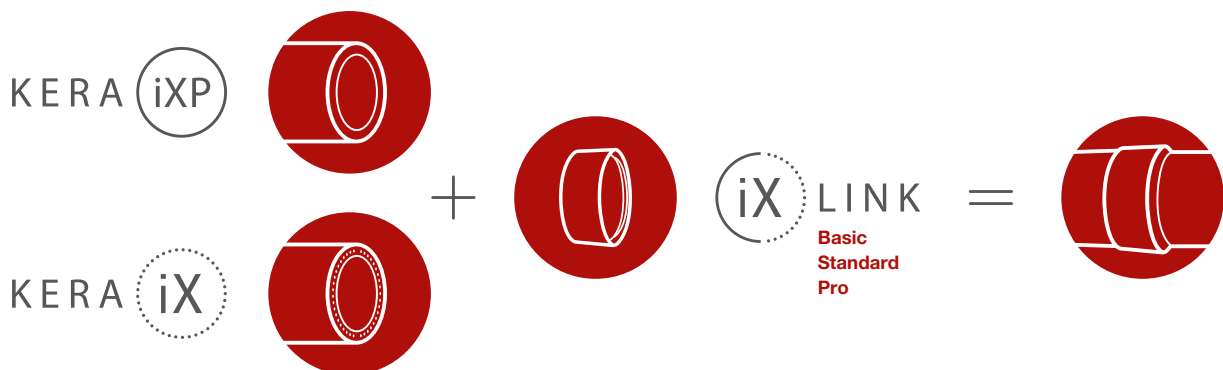



KERA.iXP with iX.LINK Standard



Cross-section stainless steel support element

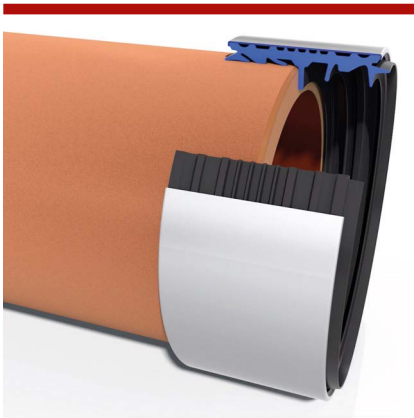

Cross-section iX.LINK

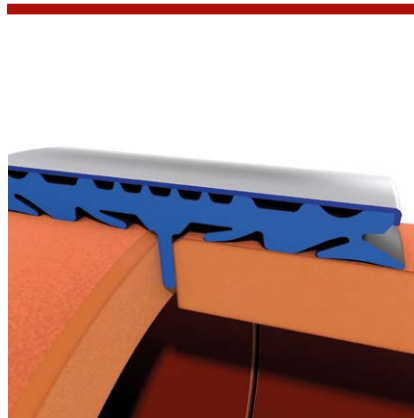

Cross-section connection KERA.iXP

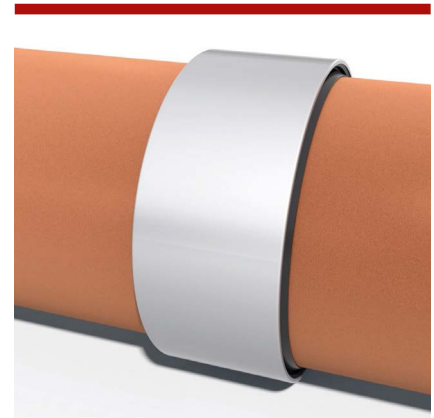

Connection KERA.iXP

TECHNICAL FEATURES

BASIC

- Plastic support element
- Tightness: 0.5 bar with shear load and angular deflection in accordance with EN 295

STANDARD

- V2A stainless steel support element
- Tightness: 1.0 bar with shear load and angular deflection (Table 2 of ZP WN 295)

PRO

- V4A stainless steel support element
- Tightness: 1.0 bar with shear load and angular deflection (Table 2 of ZP WN 295)
- Tightness: 2.4 bar with no shear load/angular deflection
- Increased corrosion resistance
- Ideally suited to use in aggressive environmental conditions

KERA.iXP PIPES

Nominal Size	Length	Strength Class	Crushing Strength	Weight	Joint System
DN	cm		FN kN/m	Kg/Piece	
200	250	240	48	88	X *
250	250	240	60	117	X *

KERA.iXP JUNCTION 45°

Nominal Size	Specification	Branch size	Length	Strength Class	Weight	Joint System
DN	Angle	DN	cm		Kg/Piece	
200	45°	150	60	240	25	X *
250	45°	150	60	240	34	X *

KERA.iXP INLET CONNECTORS

Nominal Size	Length	Strength Class	Crushing Strength	Weight	Joint System
DN	cm		FN kN/m	Kg/Piece	
200	60	240	48	24	X *
250	60	240	60	34	X *

* iX.LINK connections available in Basic, Standard and Pro versions

KERA.iXP OUTLET CONNECTORS

Nominal Size	Length	Strength Class	Crushing Strength	Weight
DN	cm		FN kN/m	Kg/Piece
200	60	240	48	24
250	60	240	60	34



*Sustainability
to the home*

EVOLUTION AS INNOVATION KERA.iX WITH HOLLOW CHAMBERS

KERA.iX – a pipe unlike any other, ever. Until today, material-related limits have made it impossible to manufacture vitrified clay pipes of greater wall thicknesses to handle even higher load capacities. The amazing solution to this problem was found in the construction plans offered by nature. Our engineers have exploited a principle, proven over millions of years, to develop a pioneering product. The integration of hollow chambers into the pipe wall starting from DN 400 changed the entire geometry and yielded a product of enormous strength, at the same time considerably reducing weight and the amount of material used.

This nature-oriented lightweight construction forms the basis for our new generation of vitrified clay pipes called KERA.iX.



KERA.iXH ROHRE

Nennweite	Baulänge	Tragfähigkeitsklasse	Scheiteldruckkraft	Gewicht	Verbindungs-system
DN	cm		FN kN/m	kg/St.	
150	175	-	40	42	X

TRENCHLESS CONSTRUCTION

*Unnoticed, undisturbed...
and easy on the environment*

For more than 30 years, trenchless construction has offered many convincing advantages – economically, environmentally, and socially.



PROTECTING THE EARTH'S SURFACE

- Minimal above-ground operations
- Environmentally friendly – easy on flora and fauna



WORKER PROTECTION

- Very high working safety

ENHANCED SERVICE LIFE

- Particularly high structural quality and safety of the wastewater system
- High reserves of the jacking pipes for sewer operation
- Construction method with lowest potential for subsidence



SHORTER CONSTRUCTION TIMES

- No particular interference with the technical infrastructure
- Citizen-friendly: no interference with day-to-day life on the surface, e.g. in shopping streets or traffic routes; no noise pollution

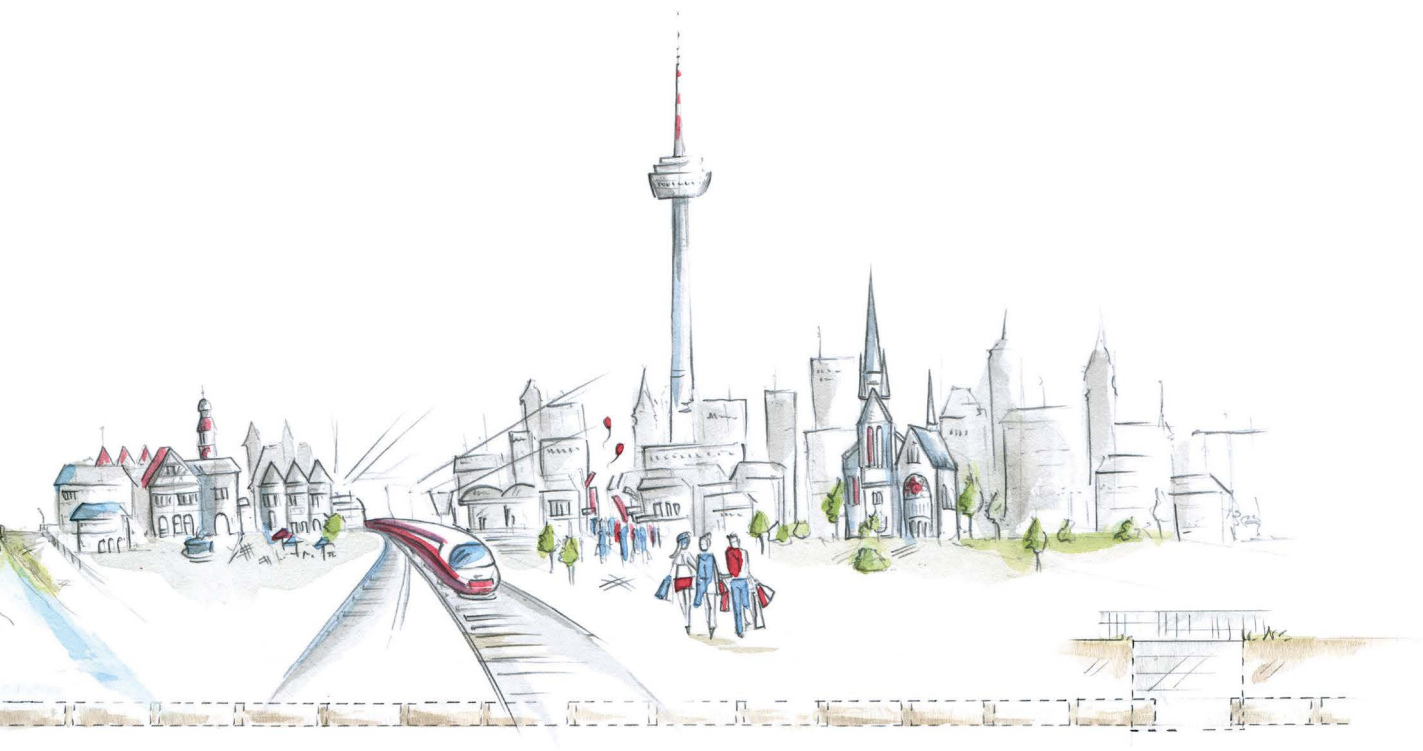

GROUNDWATER PROTECTION

- Easy on groundwater resources
- No need to lower groundwater levels to build

POSITIVE ENERGY BALANCE

- Less building and transport equipment
- Shorter transport distance
- Substantial reductions in CO₂ emissions and fine dust

KERA.DRIVE

TRENCHLESS CONSTRUCTION RANGE OF JACKING PIPES

The installation of wastewater pipes using trenchless construction is becoming increasingly important, limiting as it does the negative impacts on road traffic, residents and the surrounding natural environment caused by construction work. The KERA.Drive range of jacking pipes covers all of the system components you need for contemporary new constructions or for the targeted renovation of existing sewer systems using pipe-jacking construction. The range includes a broad selection of vitrified clay jacking pipes.

POTENTIAL APPLICATIONS

- Construction of new sewers
- Development of new residential zones
- Renewal of existing systems
- House connections
- Crossing of roads and highways
- Crossing of railway tracks and waterways
- Creation of protective pipelines for cables, etc.



KERA.Drive Jacking pipe DN 150



KERA.Drive Jacking pipe DN 200



Joint type 1

KERA.DRIVE JACKING PIPES SMALL-DIAMETER PIPES

Our smaller-diameter KERA.Drive jacking pipes have proven themselves over many years of use, both for house connections and for main sewers up to DIN 200.

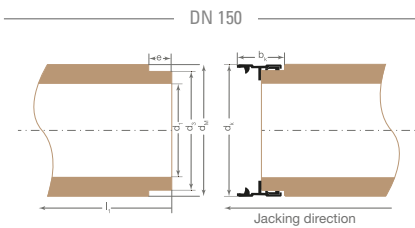

Glazed both inside and outside, guide ring made of glass-fiber-reinforced polypropylene

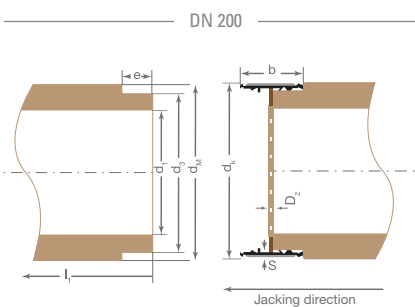

Glazed both inside and outside, coupling made of corrosion-resistant stainless steel in accordance with EN 295, with integrated rubber joint and pre-assembled thrust ring made of wood P5 in accordance with DIN 312.

KERA.DRIVE VITRIFIED CLAY JACKING PIPES DN 150 AND DN 200

			DN 150	DN 200
Internal Diameter	d_1	mm	149 ±2,5	199 ±2,5
Spigot Diameter	d_3	mm	186 ±2	244 ±2
External Pipe Diameter	d_M	mm	213 +0/-4	276 +0/-4
Assembly Depth	e	mm	50	49
Pipe Length	l_1	mm	997	990
Coupling Diameter	d_k	mm	207	261
Coupling Thickness	s_k	mm	-	1,5
Coupling Width	b_k	mm	103	103,1
Thickness of Thrust Ring	D_z	mm	-	10

KERA.DRIVE JACKING PIPES

MEDIUM AND LARGE-DIAMETER PIPES



After the sintering process, our medium and large-diameter jacking pipes obtain a particularly smooth surface with minimal frictional resistance and high resistance to biological and chemical substances. Because of the material-specific smooth surface, glazing is not required. KERA.Drive jacking pipes are ideal for wastewater disposal from households and industry.

Through our cooperation with external monitoring institute MPA NRW, our jacking pipes are continually being inspected. They comply with all of the requirements of DIN EN 295, and also have unrestricted approval from the German Federal Railway Authority for installation underneath rail tracks.



KERA.Drive jacking pipes DN 250



KERA.Drive packaging unit



KERA.Drive joint detail

KERA.DRIVE JACKING PIPES MEDIUM DIAMETERS

Our KERA.Drive pipes in the DN 250 and DN 300 diameter ranges are available for jacking sewers of all kinds. The pipes feature a specially developed coupling system that easily withstands internal and external pressure exceeding 0.5 bar, making them the perfect solution for a wide range of potential applications.

KERA.DRIVE VITRIFIED CLAY JACKING PIPES DN 250 AND DN 300

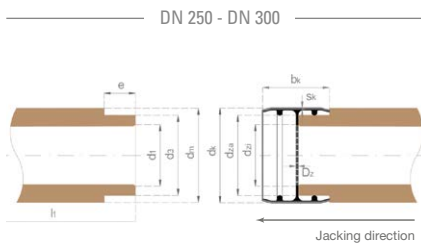

Coupling made from corrosion-resistant stainless steel in accordance with EN 295 with integrated pre-installed rubber thrust ring.

			DN 250	DN 300
Internal Diameter	d_1	mm	253 ±4	305 ±5
Spigot Diameter	d_3	mm	331,5 + 0/-1	388,5 + 0/-1
External Pipe Diameter	d_M	mm	361 + 0/-8	417 + 0/-10
Assembly Depth	e	mm	55	55
Pipe Length	l_1	mm	996/1996	996/1996
Coupling Diameter	d_k	mm	349,5	405,5
Coupling Thickness	s_k	mm	1,5	1,5
Coupling Width	b_k	mm	104	104
Thickness of Thrust Ring	D_z	mm	5	5



KERA.Drive jacking pipes DN 500



Packaging unit



Joint detail

KERA.DRIVE JACKING PIPES LARGE DIAMETERS

Our jacking pipes with nominal sizes DN 400 to DN 600 have a new intelligent joint system.

The joint system consists of two identical mechanical joints. The seal is pre-installed beneath the coupling on one side. The second joint and the required thrust ring are supplied separately to ensure the greatest possible protection from weather-related influences. While the thrust ring is used on the coupling side, the second joint is simply attached and fixed to the factory-machined groove at the spigot. Note that the joint, after mounting, at first projects beyond the facing of the spigot.

When the pipes are brought together – that is, when the spigot is inserted – the joint is rolled back and slides over the spigot with minimal friction. The joint material is so constructed that the use of lubricant during assembly on site is neither recommended nor necessary. This KERA.Drive joint system reliably withstands an internal and external pressure exceeding 0.5 bar.

OPERATING PRINCIPLE OF THE MECHANICAL JOIN

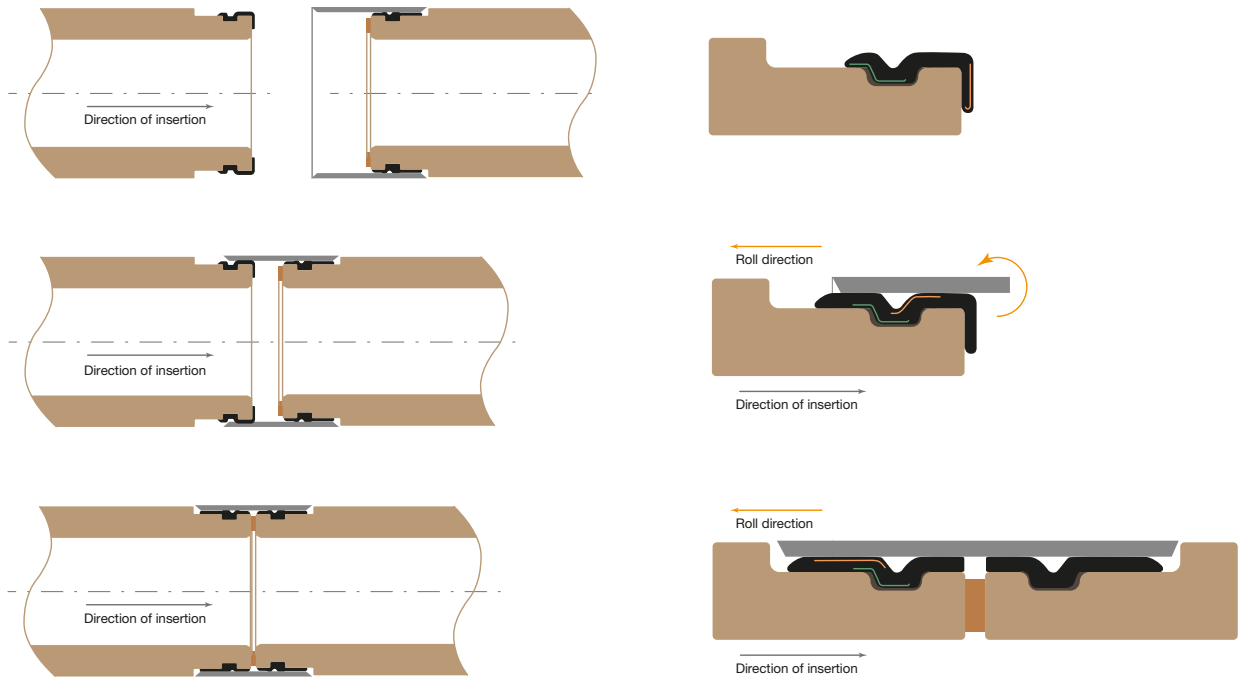

KERA.DRIVE VITRIFIED CLAY JACKING PIPES | DN 400, DN 500 AND DN 600

			DN 400	DN 500	DN 600
Internal Diameter	d_1	mm	406 ± 5	494,5 ± 5	609 ± 5
Spigot Diameter	d_3	mm	534 +0/-1	616,5 +0/-0,5	738 +0/-1
External Pipe Diameter	d_m	mm	557 +0/-10	644 +0/-10	765 +0/-14
Assembly Depth	e	mm	55	55	55
Pipe Length	l_1	mm	984/1984	984/1984	984/1984
Coupling Diameter	d_k	mm	540,6	628,5	744,6
Coupling Thickness	S_k	mm	2	2	2
Coupling Width	b_k	mm	115	115	115
Thickness of Thrust Ring	D_z	mm	18	18	18

DN 400-600

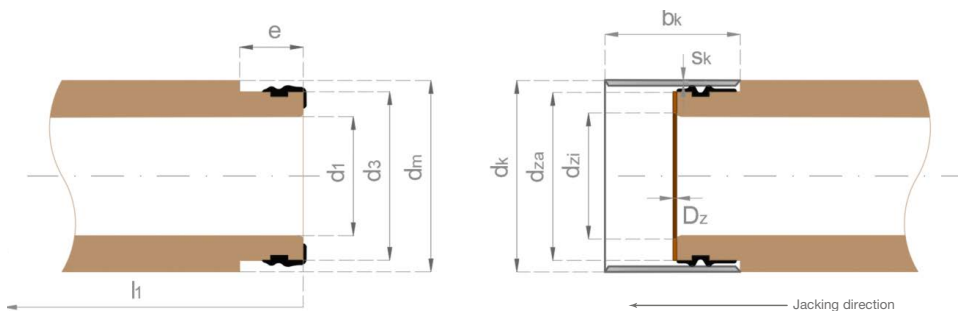

Coupling made of corrosion-resistant stainless steel in accordance with EN 295 with pre-installed rubber joint and thrust ring made of wood composite.



Shaping of pipes



Thrust ring



Post-production storage

KERA.DRIVE VITRIFIED CLAY JACKING PIPES | DN 150 – DN 600

DN	d _m	Length	Weight	Jacking Force*		Crushing Strength	Longitudinal Pressure Strength
				Pilot Pipe Jacking	Micro-Tunneling		
mm	max. mm	m	kg/m	kN		kN/m	N/mm ²
150	213	1,00	36	150	–	64	100
200	276	1,00	60	300	–	80	100
250	361	1,00 / 2,00	100	**	**	100	100
300	417	1,00 / 2,00	120	**	**	120	100
400	557	1,00 / 2,00	240	1700	1600	160	100
500	644	1,00 / 2,00	264	2100	1900	120	100
600	765	1,00 / 2,00	338	2400	2200	120	100

* Please note:

- The maximum permissible jacking force must be calculated in each case according to the applicable regulations, e.g. DWA-A 161 of March 2014
- Values given here serve only as a guide for planning
- This is subject to the condition that the effective jacking forces are continuously monitored and logged during the jacking process
- The maximum pressure of the jacking device must be limited to the permissible jacking force

** Data available on request

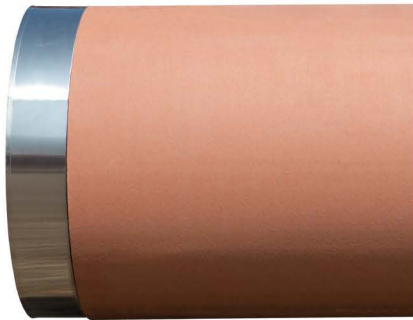

Manhole connector part A
DN 250 - 300



Manhole connector part B
DN 250 - 300



Manhole connector part C
DN 250 - 300

MANHOLE CONNECTORS

Manhole Connectors	Nominal Size	Length*
	DN	m
A, B, C	200	0,33 und 0,50 with primer
A, B, C	250–300	0,33
A, B, C	400–600	0,33 und 0,66

* Other lengths available on request



Special joint element for DN 150



Stopper DN 150

JACKING ACCESSORIES AVAILABLE ON REQUEST



Jacking connector with spigot



Transition section

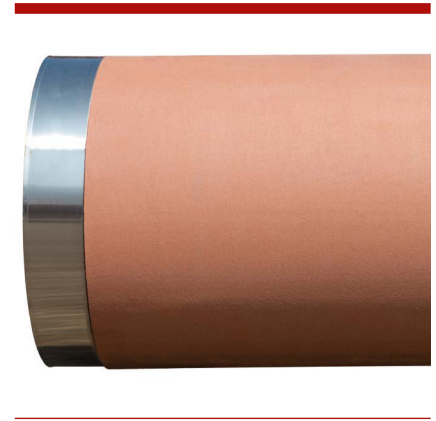

Jacking connector pipe

TRANSITION SECTIONS AND JACKING CONNECTORS

	Nominal Size	Length
	DN	m
Jacking Connector cut at one or both ends	150–200 250–600	between 0,3 and 1,0 between 0,3 and 2,0
Jacking Connector Pipes (short pipes)	250–600	between 1,0 and 2,0m*

* Only available custom-made after prior consultation.

Custom-made products, such as transitions from jacking pipes to socket pipes, can be manufactured individually after consultation.

EXAMPLES OF MANHOLE CONNECTION OPTIONS

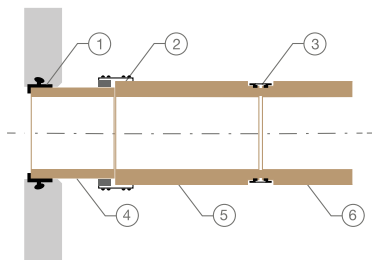

- 1 Factory-fitted BKK jointing element
- 2 Flexible coupling type 2B with compensation element
- 3 Coupling
- 4 Jacking connector cut at one end
- 5 Jacking connector for jacking pipe cut at one end
- 6 Jacking pipe

THE ADVANTAGES ARE ENORMOUS

While wastewater jacking pipes made of vitrified clay are being installed beneath the surface, life above ground goes on largely disturbed. Apart from the start and target pits – and, depending on the distance covered, a few intermediate shafts – there are no above-ground restrictions of any significance along the entire course of the installation. Transport routes, for example, don't suffer from traffic jams, nor business from turnover reductions, nor towns from major construction sites. Noise and mess are mostly avoided, CO₂ emissions and fine dust are considerably reduced, streets are not torn up, and flora and fauna are protected. In short: compared to open-trench construction, trenchless pipe laying reduces economic losses and environmental stress to a minimum.

*The mole principle:
the work goes on underground –
on top you see nothing at all.*

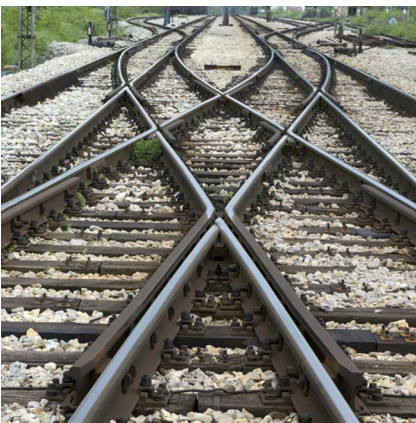

Unnoticed.



Undisturbed.

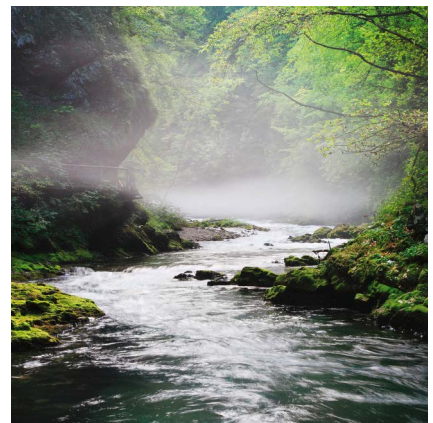

Easy on the environment.



JACKING TECHNOLOGIES

JACKING: UNDERGROUND CONSTRUCTION

We supply jacking pipes for main sewers and house connections.

NEW CONSTRUCTION

- Pilot pipe jacking
 - with soil displacement
 - with soil removal
- Microtunneling
 - with auger spoil removal
 - with slurry shield
- Manned pipe jacking

RENEWAL

- Pipe-Eating
- Burstlining (related method)



NEW CONSTRUCTION

MAIN SEWERS PILOT PIPE JACKING

This guided jacking method is used primarily for constructing smaller-diameter pipe systems.

WITH SOIL DISPLACEMENT | DN 150 TO DN 1000

APPLICATIONS

- Main sewers
- House connections
- Stone-free, displaceable soils
- In groundwater with additional measures
- Pipe-system lengths up to approx. 80 m

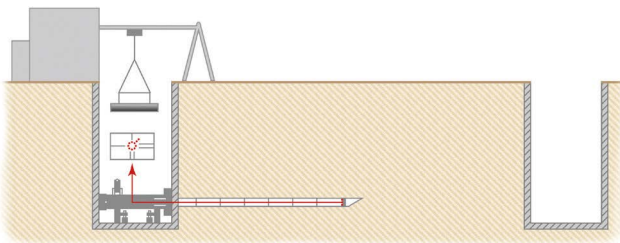

FEATURES

- Low space requirements
- Fast preparation of construction site
- Low equipment and personnel costs

PHASE 1

- Jacking of the (hollow) pilot rod through the soil to the target shaft
- Continuous monitoring of direction and gradient using guide optics

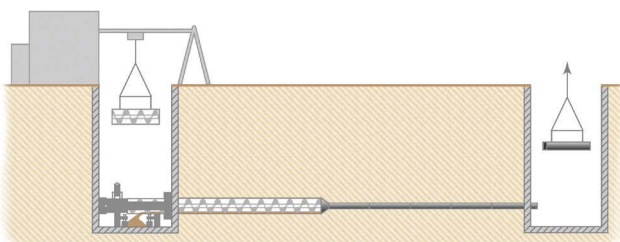

PHASE 2

- Attachment of the drill pipe (fitted with an internal auger) to the last pilot pipe
- Soil removal
- Removal of the pilot pipe in the target pit

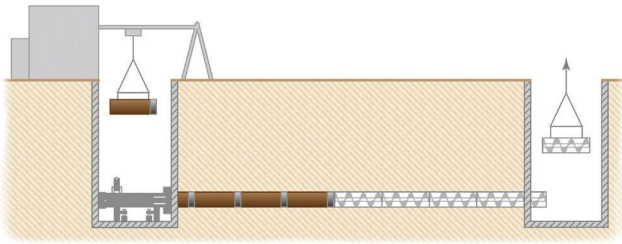

PHASE 3

- Removal of the drill pipe in the target pit
- Jacking of the vitrified clay jacking pipe

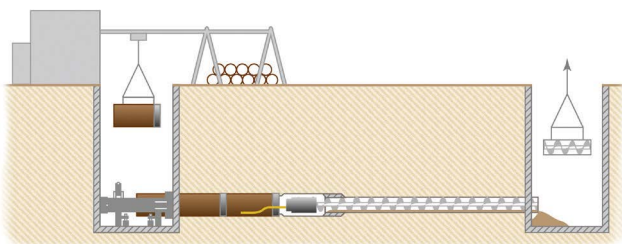

PHASE 4 (NECESSARY FROM DN 400)

- Use of an additional, directly driven reamer
- Used after the last drill pipe, followed by removal of soil in the target pit
- Jacking of the vitrified clay jacking pipe after the reamer

WITH SOIL REMOVAL | DN 300 TO DN 600

APPLICATIONS

- Main sewers
- Highly compact soils (SPT values > 35)
- In soft rock formations (hardnesses up to 10 MPa)
- System lengths up to approx. 100 m

FEATURES

- Low space requirements
- Fast preparation of construction site
- Low equipment and personnel costs
- Pipe-eating possible

Pilot pipe jacking with soil removal using a patented front-steer system is a method involving the removal of soil. It is used predominantly in soils that are non-displaceable

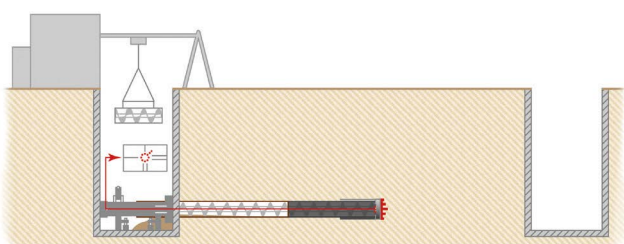

- The cutting head is guided through the soil, which is simultaneously retrieved.
- Jacking of steel pipes fitted with an auger (attached behind the cutting head).
- Removal of soil in the starting pit.
- Jacking of vitrified clay jacking pipes once the cutting head has reached the target pit.

MAIN SEWERS MICROTUNNEL CONSTRUCTION

A guided method using hydraulic presses: the pipe assembly – the tip of which is fitted with a jacking machine – is jacked from the starting pit in the direction of the target pit depending on pipe diameter and geological conditions. The distances that can be covered can be up to 200 m or even more.

The removed soil is transported by an auger or an irrigation pipe.

WITH AUGER SOIL REMOVAL FROM DN 250 TO DN 1000

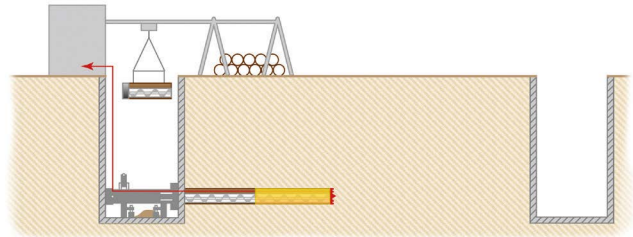

APPLICATIONS

- Main sewers DN 250 or larger
- Easily to moderately drillable soils
- In groundwater with additional measures
- System lengths up to approx. 100 m
- Insertion of the vitrified clay jacking pipes directly behind the jacking machine
- Guidance of the jacking machine by guidance cylinders in the cutting head
- Laser measurement with target board and geolaser
- Removal of soil at the cutting face by the cutting wheel
- Removal of soil by augers
- Removal of soil via conveyance pipes and augers in the starting pit
- Recovery of jacking machine in the target pit

FEATURES

- Moderate space requirements
- Fast preparation of construction site
- Low equipment and personnel costs
- Pipe-eating possible



WITH SLURRY SHIELD DN 250 AND LARGER

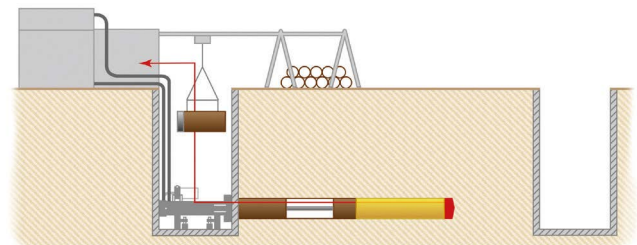

APPLICATIONS

- Broad range of applications in virtually all types of soil
- Can be used in groundwater
- System lengths up to 250m and more

FEATURES

- Reduction of groundwater level not necessary
- Long jacking distances possible
- Pipe-eating possible
- Insertion of the vitrified clay jacking pipes directly behind the jacking machine
- Guidance of the jacking machine by guidance cylinders in the cutting head
- Laser measurement with target board and geolaser
- Removal of soil at the cutting face by the cutting wheel
- Removal of the soil by slurry shields
- Separation of soil and water in the separation plant
- Recovery of jacking machine in the target pit

HOUSE CONNECTIONS

THE MOST IMPORTANT METHODS

This guided jacking method is used primarily for constructing smaller-diameter pipe systems.

PRESSURE JACKING

- Two to eight meters using the unguided horizontal pipe jacking method

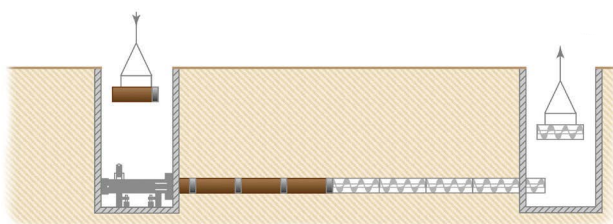
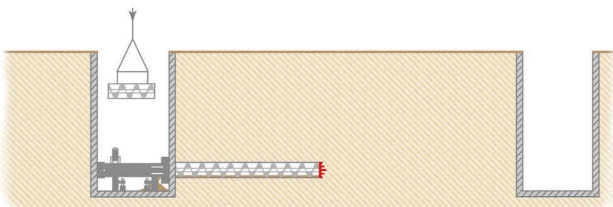

PILOT PIPE JACKING

- Pilot pipe jacking with soil displacement: using the guided pipe jacking method from starting to target pit (see also pilot pipe jacking, main sewers, p 56).

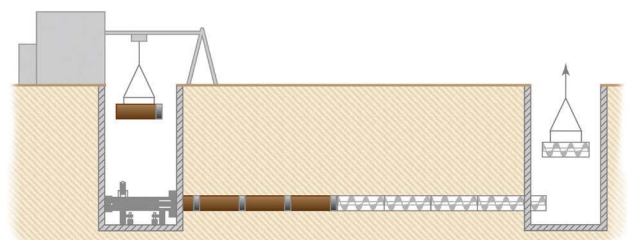
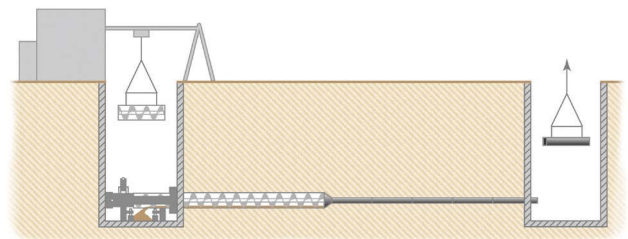
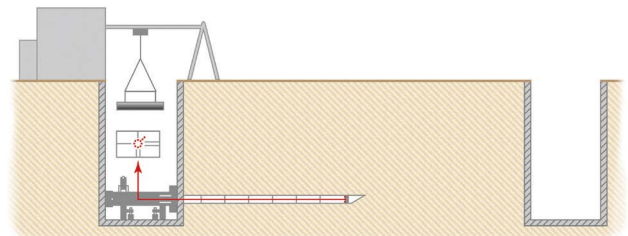

UNDERGROUND CONNECTION DN 150 TO MAIN COLLECTOR \geq DN 300

- Drill hole using a guided auger
- Drill core hole in the main channel
- Insert vitrified clay jacking pipes with special jointing element on the first jacking pipe

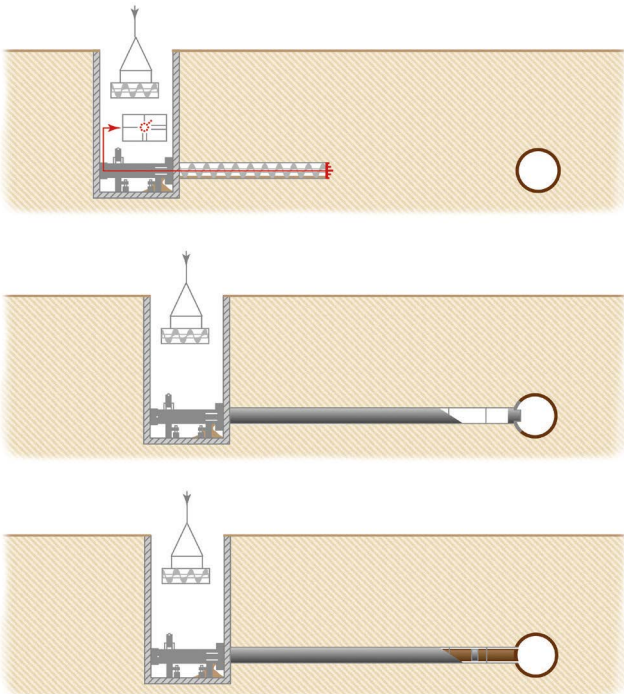

DRILLING BLIND BOREHOLES DN 150 AND DN 200

- A blind borehole is a drillhole without a target pit
- Insert vitrified clay pipes into steel pipes
- Retract steel pipes into starting pit

DRILLING FROM A PIPE \geq DN 1200

- Drilling underground house connections from accessible collectors
- Unguided from sewers DN 1200 or larger
- Guided from sewers DN 1800 or larger

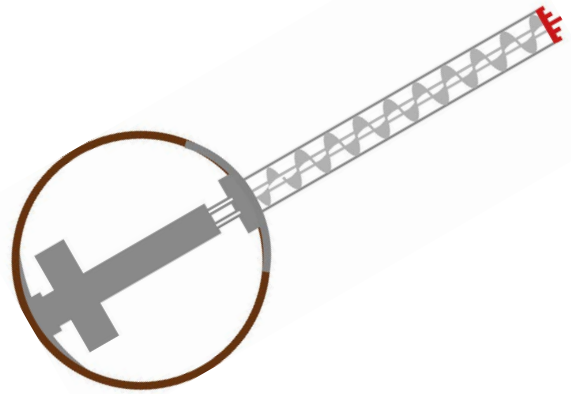

“BERLINER BAUWEISE” THE BERLIN METHOD

In the Berlin Method, house connections are drilled from existing starting, target, pass-through, or intermediate pits — or are connected using the open-trench method.

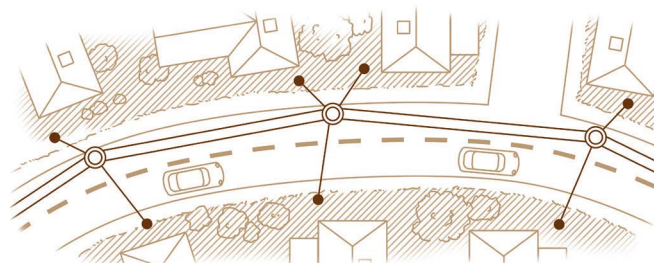

RENEWAL METHODS

PIPE-EATING

Pipe-eating is a guided variant of the jacking method and involves the “swallowing” and destruction of the defective old pipe (no steel pipes, no reinforced concrete pipes).

DN 250 AND LARGER APPLICATIONS

APPLICATIONS

- Main sewers DN 250 or larger
- The new pipe must have the same or a larger diameter than the pipe to be replaced
- Identical cross-section/enlargement possible the old pipe must be backfilled

The following technologies can be used for this method:

- Microtunnel construction with auger soil removal
- Microtunnel construction with slurry shield
- Pilot pipe jacking with soil removal (front steer)

FEATURES

- The new pipe does not lie on a bed of scrap, but in the natural substratum/bedding material
- The new pipe assembly can be constructed along the same invert or axis

Pipe-eating enables new pipes to be jacked in the area of the old existing sewer. The pipes are not jacked in the natural subsoil, which means a lower geological risk.

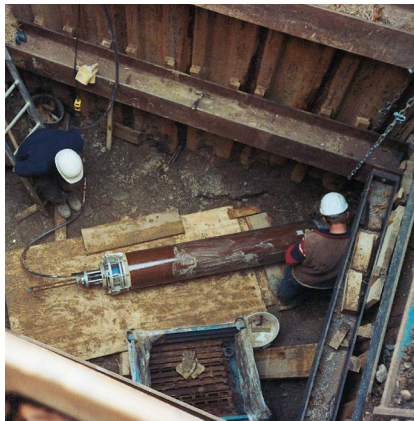

BURSTLINING

Burstlining is an unguided jacking method.

DN 150 AND LARGER

APPLICATIONS

- For main sewers DN 250 or larger
- The new pipe must have the same or a larger diameter than the pipe to be replaced
- Identical cross-section/enlargement possible
- The old pipe must be backfilled
- Destruction and displacement of the old pipe into the surrounding subsoil
- Simultaneous replacement by vitrified clay jacking pipes of the same or smaller cross-section

FEATURES

- Guided method
- The new pipe does not lie on a bed of scrap, but in the natural substratum/bedding material
- The new pipe assembly can be constructed along the same invert or axis

PITS

STARTING AND TARGET PITS

Preparation of the starting and target pits is an essential part of jacking operations. The way they are excavated and lined is primarily dependent on the subsoil conditions, the jacking method to be employed, and the depth of the jacking operations. Pilot pipe jacking and microtunneling can be started from relatively small starting pits.

MINIMUM DIMENSIONS OF STARTING AND TARGET PITS

Dimensions	Starting Pit	Target Pit
DN 150	DN 2000/1500 2,00 m x 1,50 m	2,00 m x 1,50 m 1,00 m x 1,00 m
DN 200–DN 300 Pipes 1.00m in length	DN 2000 2,80 m x 2,50 m	DN 2000 (1500) 2,00 m x 2,00 m
DN 250–DN 800 Pipes 2.00m in length	5,00 m x 4,00 m (with compact press system)	DN 2500 (2600) 2,50 m x 2,50 m
DN 900–DN 1200 Pipes 2.00m in length	5,00 m x 4,00 m (with compact press system) 8,00 m x 4,50 m otherwise at least 8,00 to 10,00 m x 4,50 m	3,50 m x 3,00 m

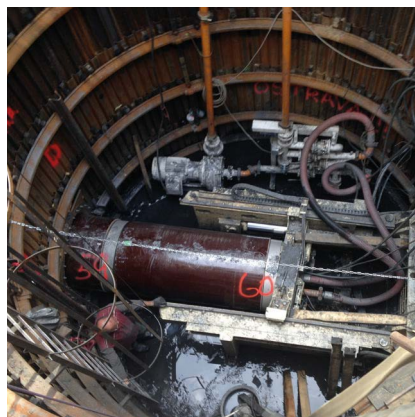
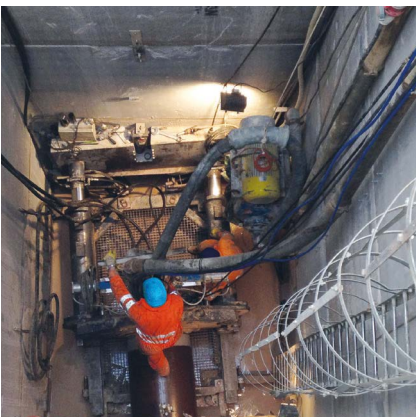

TESTS

TESTING PIPES BEFORE STARTING JACKING

- Correct fit of the coupling
- Correct fit of the profile ring (jointing ring)
- Correct fit of the thrust ring
- Undamaged pipe surfaces
- Dusting with talcum powder DN 150 to DN 600
- Testing of spigots with spigot test device DN 150 to DN 600



KERA.PORT



KERA.PORT MANHOLES

CORROSION-RESISTANT AND SECURE

Our manholes complete our range of high-quality system solutions. Public authorities are increasingly focusing on manholes for wastewater systems. For a number of reasons, wastewater today is considerably more aggressive than it was a few years ago. The main cause of this is changes to social demographics. In addition, wastewater today has to be transported over greater distances. For treatment plants to work efficiently, it is crucial to avoid unwanted water infiltrating into wastewater systems through insecure manholes.

Ready for extreme requirements

CONSTRUCTION FEATURES

- KERA.Port manholes are monolithic up to transport height
- Extension pieces are delivered with integrated joint
- Cover slabs complete the manhole; for DN 1000 manholes, an optional taper is available
- The corrosion-resistant inner lining of channel elements/cover slabs/tapers is made of polyurethane (PU) up to DN 1000

PU bottom element:

DN 600
DN 800
DN 1000

We're happy to make you an offer for an individual solution for DN 600 and larger. The interior construction design is completely flexible.



- Structural analysis allows a possible installation depth exceeding 8 meters, documented with heavy traffic loads. Furthermore, the manholes are approved for installation within the range of railway traffic.
- With their rigid non-deformable material, the manholes are absolutely secure and won't buckle.
- Manholes with nominal sizes DN 600, DN 800 and DN 1000 are equipped with a PU bottom element as standard.
- Delivery includes the manhole base unit, extension pieces and cover slab or taper.



PROVEN PRODUCT CHARACTERISTICS

- Resistant to biogenic sulfuric acid corrosion
- High-pressure water-jetting resistance
- Temperature resistance to 45°C;° up to 60°C on request
- Environmentally compatible, sustainable
- Durability > 100 years
- High wall thickness provides strength
- Buoyancy proofed (verifiable with online calculator in Steinzeug-Infopool)
- Retrofitting of connections is possible
- Connections are integrated into manhole wall up to DN 1000
- Channel slope gradient: 0 percent as standard*
- Manhole connections: based on 5 gon spacing; smaller gradations possible
- Inlets crown-level*
- Manhole extension sections with integrated joint elements
- Cover slabs/tapers made from concrete with PU inner lining
- upper edge of taper/cover slab DIN 4034 compatible

Standard manholes come equipped with a one-piece PU bottom element, with integrated manhole connections from DN 150 to DN 400 in the pipe wall, as well as integrated buoyancy protection.

* Individual designs possible

KERA.PORT MANHOLES BUILT FOR DEMANDING CONDITIONS



Milling and cutting with millimeter accuracy

CNC TECHNOLOGY – FOR HIGH-PRECISION FINISHING

Standard manholes are manufactured from smooth pipe elements, cut precisely to the required length depending on the task at hand. In a subsequent step, mountings for the channel element and connections are carved out using CNC milling and drilling robots.

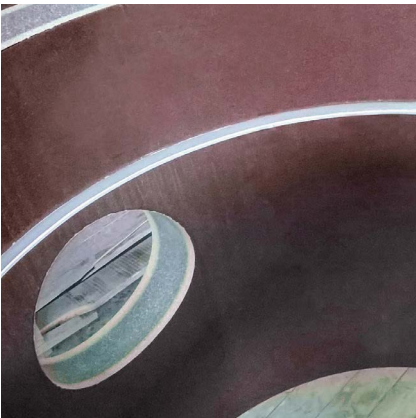

Manhole base unit prepared for bottom element

100% TIGHT SEALING – THE PU BOTTOM ELEMENT

The manhole connections integrated into the wall of standard manholes up to DN 1000 are firmly attached to the bottom element. The high-precision PU bonding (see sketch) is completed from underneath – and the prefabricated bottom element is thus securely sealed.

For out-of-the-ordinary stress caused by the soil or groundwater, an optional protective layer of PU can be added to the underside.



INTEGRATED INTERNAL BUOYANCY PROTECTION

When it comes to reliable buoyancy protection, two complement factors come into play: first, the weight of the vitrified clay material itself, and second, the internal filling of the base with concrete beneath the PU channel element.

A layer of adhesive to the PU as well as steel cables integrated into the PU channel element ensures that the concrete adheres to the channel element. Reinforcement rods anchored in the manhole wall provide a reliable connection between the pipe wall and the buoyancy protection.

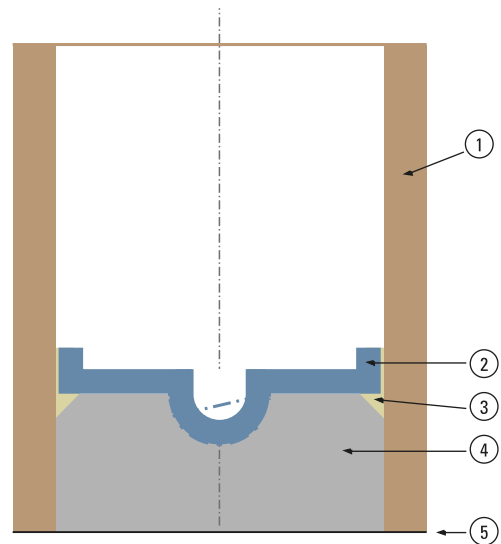

MANHOLE CONNECTIONS

Each of the manhole connections is completely integrated into the manhole wall. No socket protrusions – nothing juts out – everything terminates flush with the outer wall of the pipe. A one hundred percent smooth outer surface. Quality that only Steinzeug-Keramo offers.

- 1 | Pipe wall
- 2 | PU bottom element
- 3 | Factory-produced sealing of the channel element (PU)
- 4 | Concrete buoyancy protection
- 5 | Optional protective layer



Manhole connections

*Up to DN 1000
all around smooth
and absolutely flush*

MONOLITHIC UP TO TRANSPORT HEIGHT

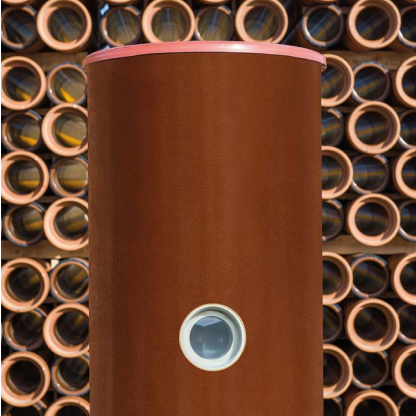

Milling and cutting with millimeter accuracy

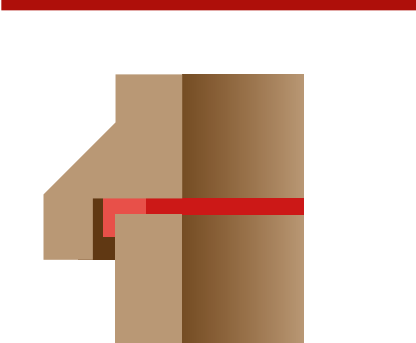

Sealing of manhole base unit/extension section
DN 600 to DN 1000

STANDARD MANHOLE AND EXTENSION SECTIONS

The useable height of the standard manhole as monolith is 1.7 meters. Individual extension sections can be supplied up to an installation height of 2.5 meters.

Extension sections for DN 600 to DN 1000 manholes have sockets with PU joints to the manhole base unit (joint K for joint system C).

Our system gives you the option of keeping the number of individual elements (standard manhole and extension sections) as low as possible at the planning stage. In addition to simplifying installation, this also makes all cleaning and maintenance processes easier. Other advantages: the fewer the individual parts, the fewer the number of connections that need to be sealed. You benefit from a high level of system security.

The sealing of the top pieces is made to protect the pipe wall over the spigot end. This means that all load weight is evenly transferred to the shaft wall.



ALL SAFE AND SECURE – FROM TRANSPORT TO MAINTENANCE

Holes pre-bored in the pipe wall are designed to take rigging slings and steps. Internal stainless steel bolts and transport anchors, attached using a wall-plug system, can be removed after use.

All of these represent optimal precautionary measures: for safety during transport, installation and maintenance, and for long-term reliable functionality.



Internal transport anchor

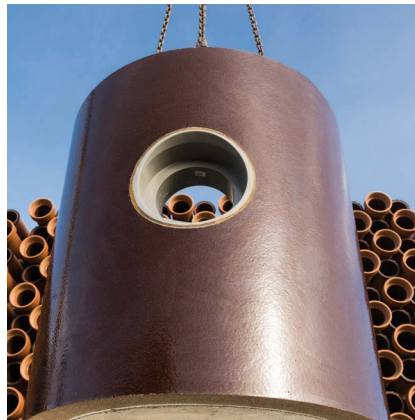

Connection integrated into the pipe wall



PRODUCT RANGE

STEPS TO MEET YOUR NEEDS

Manholes are delivered as standard without steps. On request, various kinds of steps can be installed: standard rungs, step irons and stainless steel steps. We particularly recommend the use of ladder systems made of aluminum or stainless steel, which are normally attached to stainless steel bolts set into the inner wall. Other variants are available on request.

The manhole base unit DN 600 to DN 1000 are basically equipped with a one-piece PU bottom element that allows connections from nominal size DN 150 upwards. Extension sections are fitted with proven joint systems in accordance with EN 295 and permanent pressure transfer.

Cover slabs come as standard with a corrosion-resistant PU lining from nominal size DN 800 upwards.



RELIABILITY FROM TOP TO BOTTOM

Delivery includes the manhole base unit, extension pieces and cover slab or taper, as applicable. Standard manholes are equipped with a one-piece PU channel element with integrated manhole connections from DN 150 to DN 400 in the smooth pipe cylinder, as well as internal integrated buoyancy protection.

MANHOLE DN 600 WITH COVER SLAB

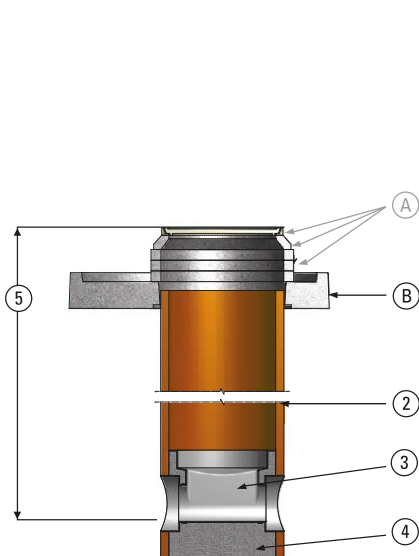

- A* Manhole top and adjusting elements
- B Cover slab
- 2 Vitrified clay manhole
- 3 Prefab bottom element (PU)
- 4 Buoyancy protection (concrete)
- 5 Manhole height (Ground level to flow line)

MANHOLE DN 800 – DN 1000 WITH COVER SLAB

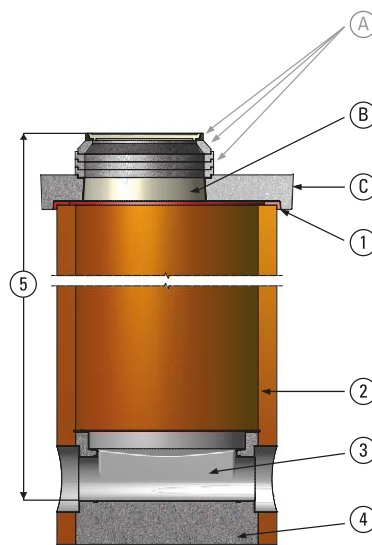

- A* Manhole top and adjusting elements
- B Cover slab inner lining (PU) for corrosion protection
- C Cover slab
- 1 Factory cast jointing element (PU)
- 2 Vitrified clay manhole
- 3 Prefab bottom element (PU)
- 4 Buoyancy protection (concrete)
- 5 Manhole height (Ground level to flow line)

MANHOLE DN 1000 WITH TAPER

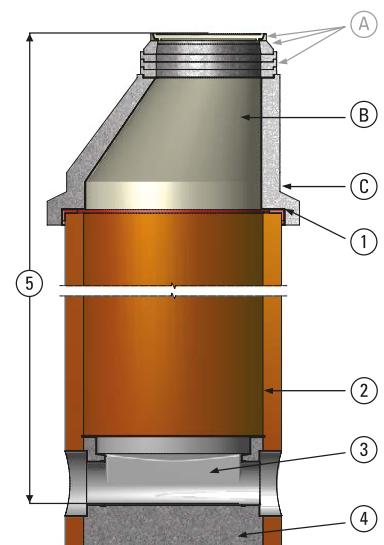

- A* Manhole top and adjusting elements
- B Taper inner lining (PU) for corrosion protection
- C Taper
- 1 Factory cast jointing element (PU)
- 2 Vitrified clay manhole
- 3 Prefab bottom element (PU)
- 4 Buoyancy protection (concrete)
- 5 Manhole height (Ground level to flow line)

* Not supplied by Steinzeug-Keramo

COVER SLAB/TAPER YOU HAVE THE CHOICE

For sizes DN 800 to DN 1000, concrete cover slabs are produced. These are reinforced to the requirements of traffic load D 400. Up to DN 1000, the cover slabs are finished with corresponding recesses on the underside to secure them against displacement.

The undersides of the cover slabs and the inner side of the taper are given a corrosion-resistant PU covering.

Recesses of different sizes can be order for the top of the cover slabs, for attaching a wide range of covers. To adjust for the final height, compensating elements can, depending on design, be added on site (these are not in our product range). The sizes listed in the following table are intended only as a guide and are subject to design adaptations.

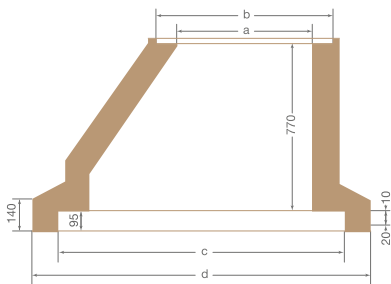

KERA.Port taper for DN 1000 manhole

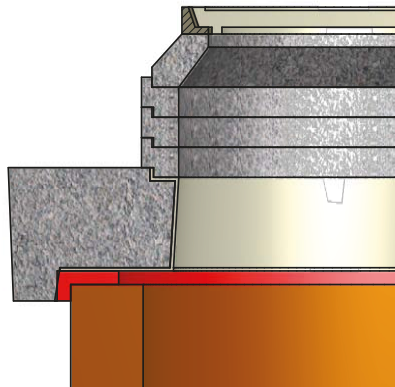

Integrated PU joint/joint tape to accommodate cover slab/taper

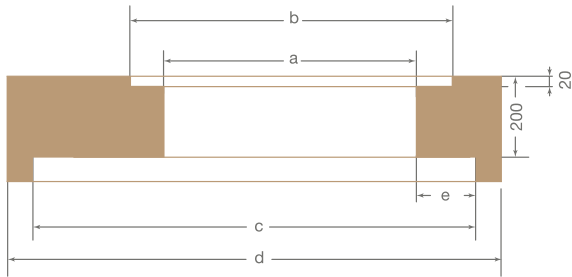

KERA.PORT COVER SLABS FOR MANHOLES DN 800 - DN 1000 WITH PU COATING

Manhole DN	a = Opening (entrance)	b	c	d = External Diameter	e
mm	mm	mm	mm	mm	mm
800/TKL 120	625	805	976	1240	100
800/TKL 120	625	625	976	1240	175
800/TKL 120	700	775	976	1240	100
1000/TKL 95	625	805	1203	1470	103
1000/TKL 95	625	625	1203	1470	289
1000/TKL 95	700	775	1203	1470	103
1000/TKL 95	800	970	1203	1470	103
1000/TKL 95	800	800	1203	1470	201,5

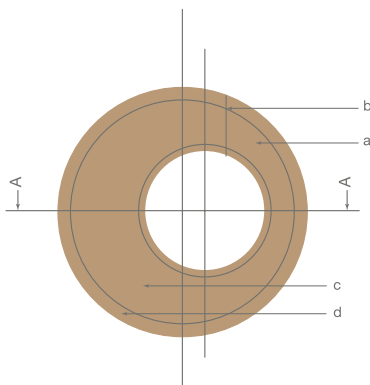

KERA.PORT TAPER FOR MANHOLES DN 1000 WITH COATING

Manhole DN	a = Opening (entrance)	b	c	d = External Diameter
mm	mm	mm	mm	mm
1000/TKL 95	625	805	1303	1543

KERA.PORT MANHOLE DIMENSIONS/STRENGTH CLASS DN 600 – DN 1000

Manhole DN	Estimated Weight					Additional Characteristics					
	Manhole Base Unit Usable Height 0.7m	Manhole Base Unit Usable Height 1.7m	Extension Section	Cover Slab	Taper	Crushing Strength	Inner Diameter	Wall Thickness	External Diameter	Possible Connections	Max. Outer Diameter Extension Section Socket Size*
DN	t	t	t	t	t	kN/m	mm	mm	mm	DN	mm
600/TKL 95	0,5	0,73	0,23	0,3	–	57	597	45	687	150–250/TKL 160	860
800/TKL 120	0,97	1,44	0,48	0,6	–	96	792	70	932	150–300/TKL 240	1150
1000/TKL 95	1,43	2,24	0,81	0,85	0,71	110	1007	76	1159	150–500/TKL 160	1450

Note: The component weights given are only a guide. They vary depending on the particular design. Upon delivery of the manhole, its weight is recorded either on the delivery note or directly on the manhole itself.

MANHOLE CONNECTIONS HIGHEST PRECISION

For manhole connections, the minimum distance in gon between the outlet and the connections has to be taken into consideration, depending on the connection size. These are available in a table on the Steinzeug-Keramo Infopool, organized by manhole dimensions.

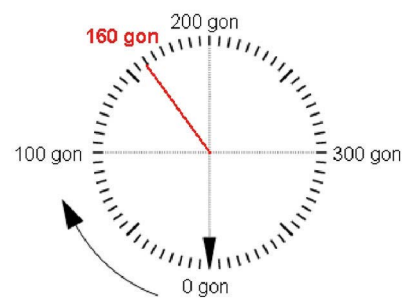

CONNECTING ELEMENTS, INLETS AND OUTLETS

Manholes from DN 600 to DN 1000 come with a non-sloping PU bottom element with PU manhole connection elements integrated into the pipe wall. The berm is at crown height. Standard finishing of the inlets and outlets is crown-level, and based on 5 gon spacing. Smaller gradations are also possible depending on the manhole diameter.

CHOOSE YOUR MANHOLE IN THREE STEPS WITH THE MANHOLE CALCULATOR FROM STEINZEUG-KERAMO

With the online manhole calculator available in the Steinzeug Infopool, you can calculate your manhole in just a few minutes by filling out the straightforward online form.

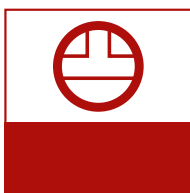

MANHOLE

Vitrified clay manholes DN 800 to DN 1000 can be assembled and calculated.



DOCUMENTING THE STATICS/BUOYANCY SAFETY USE OUR BUOYANCY CALCULATOR

Structural calculation for our manholes allows for a depth of up to 8m with traffic loading. For special applications please enquire with details of your expected load.

The manholes are equipped from the factory with buoyancy protection, without the need for a projecting manhole foot. This allows the manholes to be installed even in tight conditions.

You can use our “Manhole Buoyancy Calculator” in the Steinzeug Infopool to check the worst-case scenario for your particular situation – installed and connected sewer pipes in an unfilled, flooded trench.

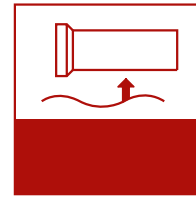

BUOYANCY

Both for vitrified clay manholes and vitrified clay pipes, documentation can be supplied that rules out floating (buoyancy) of the construction.

WATER TABLE

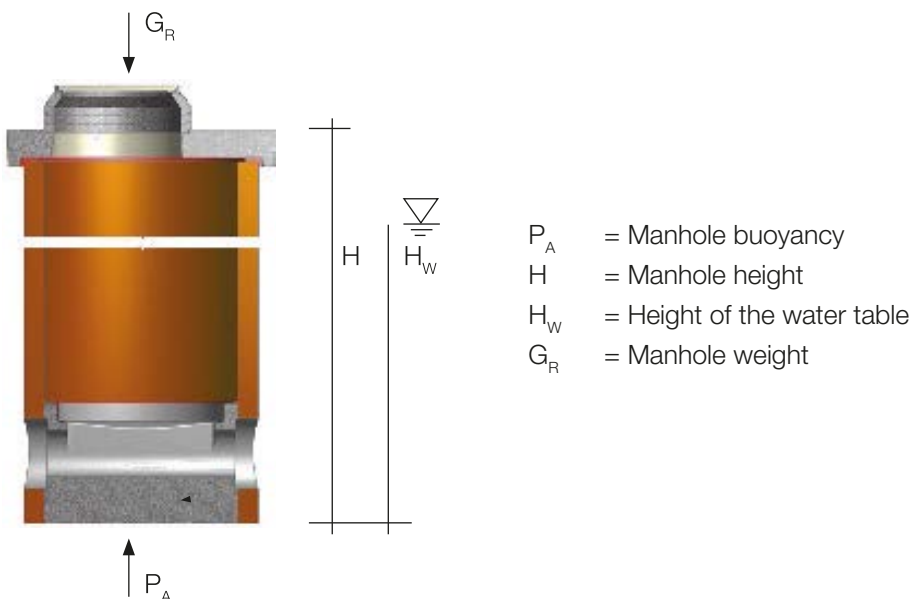

SPECIAL SOLUTIONS

BUILD ON OUR FLEXIBILITY

Individual solutions are possible to meet special requirements, e.g. gate-valve connections, baffle plates for energy conversion or for pump installations. Manholes can also be connected in series for special treatment purposes or separators.



Manhole on main pipe



Gate-valve installation



Special manhole with connections for pressure pipes in the extension section

PRESSURE PIPE END MANHOLE

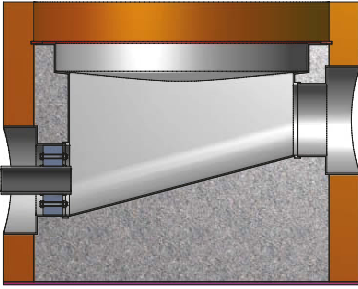

With pressure pipe end chambers, pipe sleeves (for example Doyma or Link Seal, included in delivery) are installed in the standard manhole connections on the pressure side. The diameter of the pressure pipe has to be specified. Pipe sleeves can also be integrated into vitrified clay branches as a special order.

MANHOLES WITH CHANNEL MADE OF VITRIFIED CLAY

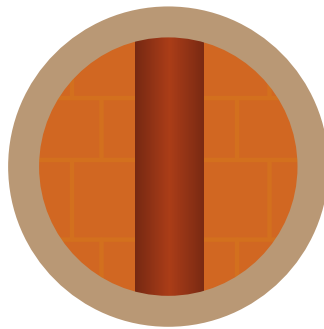
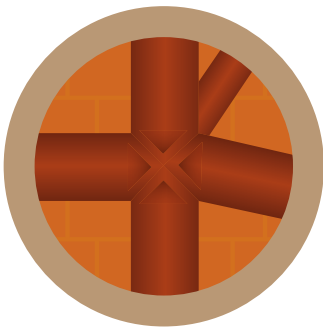

With this solution, the berm is tiled and grouted with clinker plates to make it corrosion-resistant.

Size range: DN 800, DN 1000.

RETROFITTED CONNECTIONS



Retrofitted connections can be bored using diamond-coated drilling heads. From DN 125 to DN 200, we offer connecting elements for the various wall thicknesses in our range of accessories.

Larger sizes can be connected using short pipes.

Example of retrofitted connection with connecting element C

INSTALLATION

QUICK REFERENCE

During installation, the requirements of EN 1610 as well as national regulations shall be taken into account. Before being installed, all components shall be checked for damage. To ensure safe handling on the construction site, all manhole components are supplied with integrated lifting slings.

PREVENT SETTLEMENT

According to EN 1610, manholes should be installed so as to exclude settlement as much as possible. If the ground on-site is not prone to settling, the manholes can be placed on a well-compacted, flat sand-gravel bed. An additional bedding layer of concrete or screed is recommended.

MEASURES FOR SOILS PRONE TO SETTLING

If the on-site ground is prone to settling, a reinforced concrete foundation slab must be provided according to the planner's specifications. The manhole always has to be supported on a flat surface.

The manhole base unit is to be placed onto the support and aligned according to the planning standards. To move manhole components, hoist and lifting equipment are to be chosen according to the component's weights. These weights are indicated on the delivery note as well as the component itself.



Creating a solid base

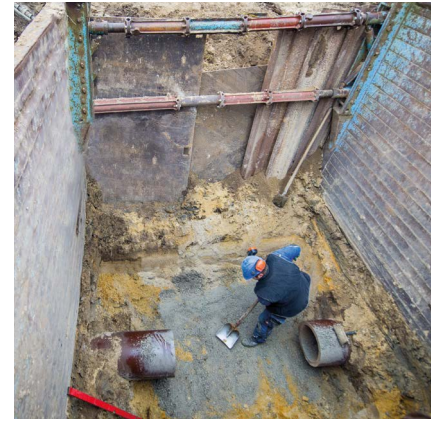

RULES FOR ADDING EXTENSIONS AND COVERING

Adding extension sections and cover slabs should be done so as to exclude any form of damage. Before assembly, all jointing elements must be coated with KERA.Mat lubricant on both sides. The order of any integrated steps must also be borne in mind during installation.

Compensating rings and manhole covers are not included in delivery. To achieve the final height, these need to be installed on-site in accordance with the manufacturer's specifications

MANHOLE CONNECTIONS AND CONNECTORS

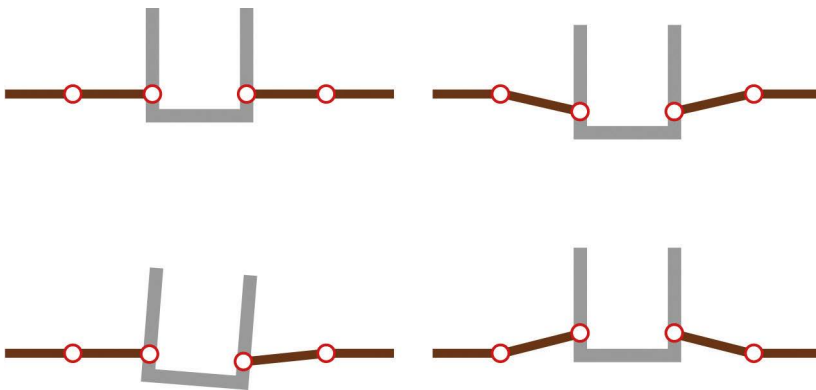

To compensate for different degrees of settling between manholes and the pipeline when making connections, connector pipes – inlet connector (GZ) and outlet connector (GA) – from the pipe range shall be used.

Operating principle of inlet and outlet connectors with different degrees of subsidence



Setting the manhole in place

Filling the trench around the KERA.Port manhole is to be carried out in layers according to EN 1610/DWA-A 139. We recommend using the excavated soil for filling the trench, if appropriate. In the immediate area of the manhole, grain size should be limited to a maximum of 40mm. Compaction is to be carried out with appropriate compaction equipment.

LEAKAGE TESTING FOR MANHOLES WITH OR WITHOUT CONNECTED PIPES

Our manholes are constructed so that all elements and connections resist water pressure from inside and out. Leakage testing is regulated by EN 1610 and DWA-A 139. The manholes can be tested both with and without connected pipes.

For manholes, Steinzeug-Keramo recommends water testing in accordance with EN 1610, which specifies: If the manhole as a component is tested separately with water, a water addition value of 0.4 l/m² wetted surface in the testing period of 30 minutes must not be exceeded. Testing takes place with the manhole filled to the bottom edge of the cover slab or taper. If the manhole testing takes place in conjunction with the pipe testing, the water addition value is a maximum of 0.2 l/m² wetted surface.

ACCESSORIES

KERA.MAT ACCESSORIES RANGE

Perfectly coordinated with pipes and fittings: the KERA.Mat original accessory range for connection technology.

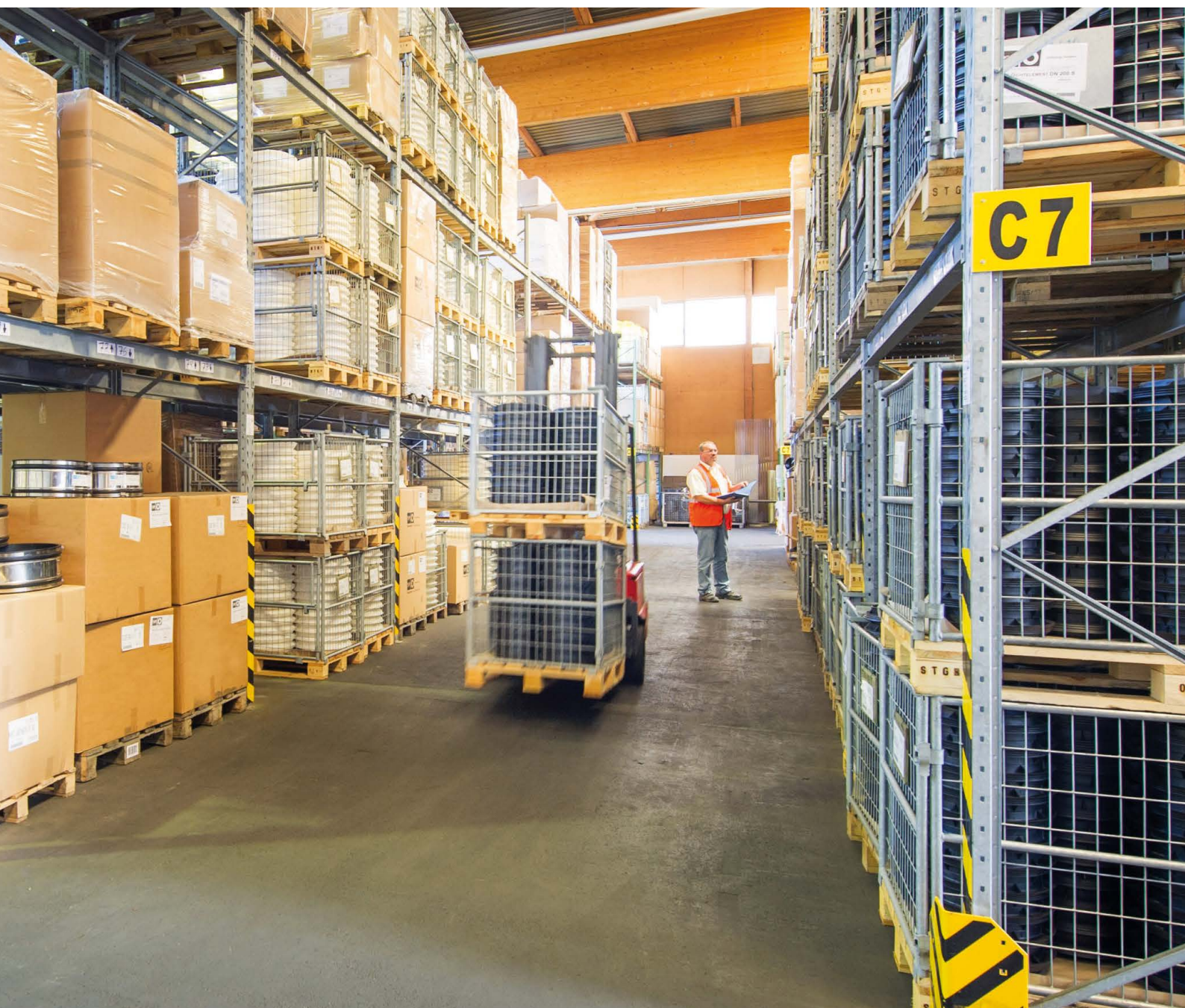

COUPLING.PRO

FOR CONNECTING TWO PIPE SPIGOTS



ONE COUPLING FOR MANY DIFFERENT APPLICATIONS

- Robust and especially safe thanks to the amount of material used
- Complies with EN 16397 for tightness, angular deflection, and shear load
- Minimization of stocks in trade depots and on construction sites
- No confusion possible
- Includes the RE-system (see page 92)

The universal solution for connecting normal-strength and extra-strength pipes: one coupling for many different applications. Not only do dealers and construction companies reduce storage space, it also prevents confusion, since it can be used for all applications with the same diameter. A further advantage is the integrated RE-System.

KERA.MAT | COUPLING.PRO

Clamping Range	Nominal Size	Strength Class	Width	Thickness	Tightening Torque
External d3 mm	DN		mm	mm	(Nm)
230–265	200	160/200/240	150	7,5	6
290–330	250	160/240	185	9,5	10
345–385	300	160/240	185	9,5	10

If there are major differences in the outside diameters of the pipes to be connected, for example in the case of normal-strength or extra-strength clay pipes, compensating rings may need to be used.



COUPLING.BASIC

TYPE 2A AND TYPE 2B

KERA.Mat COUPLING.Basic for joining two pipe spigots of type 2A (normal) or type 2B (wide), available in various diameters.

COUPLING.Basic with compensation rings in the sizes 4, 8, 12, 16, 24, and 32 mm for connecting two pipe spigots with different external diameters from 160 to 1399 mm.

Type 2B,
TOX-welded connection,
2.5 bar tightness





KERA.Mat COUPLING.Basic type 2B



KERA.Mat compensation ring

KERA.MAT COUPLING.BASIC TYPE 2A (1.4301)

Clamping Range	Nominal Size	Strength Class	Width	Thickness	Tightening Torque
External d3 mm	DN		mm	mm	(Nm)
120–135	100	34	102	3,4	6
150–165	125	34	102	3,4	6
175–190	150	34	102	3,4	6
235–250	200	160/200	102	3,4	6

Watertight to 1.0 bar

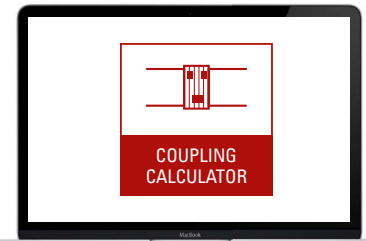

INFOPOOL COUPLING CALCULATOR

For connecting spigots, the Coupling Calculator works out the type of coupling, and if necessary, the quantity and type of compensating rings required.

Access via our website:
www.steinzeug-keramo.com

KERA.MAT COUPLING.BASIC TYPE 2B WITH RE-SYSTEM NORMAL STRENGTH *

Clamping Range	Nominal Size	Strength Class	Width	Thickness	Tightening torque
External, d3, mm	DN		mm	mm	(Nm)
120-137	100	34	150	7,7	6
140-165	125	34	150	7,7	6
175-200	150	34	150	7,7	6
225-250	200	160/200	150	7,7	10
285-310	250	160	185	9,2	10
335-360	300	160	185	9,2	10
400-425	350	160	185	9,2	13
460-490	400	160	185	9,2	13
570-600	500	120	185	9,2	13
670-700	600	95	185	9,2	20

* Watertight to 2.5 bar

KERA.MAT COUPLING.BASIC TYPE 2B WITH RE-SYSTEM UP TO DN 1200 EXTRA STRENGTH */**

Clamping Range	Nominal Size	Strength Class	Width	Thickness	Tightening Torque
External, d3, mm	DN		mm	mm	(Nm)
245–275	200	240	150	7,7	10
305–335	250	240	185	9,2	10
355–385	300	240	185	9,2	10
420–445	350	200	185	9,2	13
480–510	400	200	185	9,2	13
530–560	450	160	185	9,2	13
590–620	500	160	185	9,2	20
705–735	600	160	185	9,2	20
820–850	700	120	185	9,2	20
920–950	800	120	185	9,2	20
1060–1090	900	120	185	9,2	20
1247–1277	1000	120	185	9,2	20
1430–1470	1200	95	185	9,2	20

* Watertight to 1.0 bar for diameters larger than 820 mm

** Watertight to 2.5 bar up to 735 mm

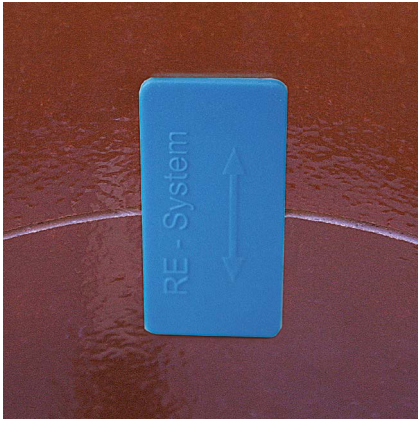

RE-System for COUPLING.Pro and COUPLING.Basic Type 2B

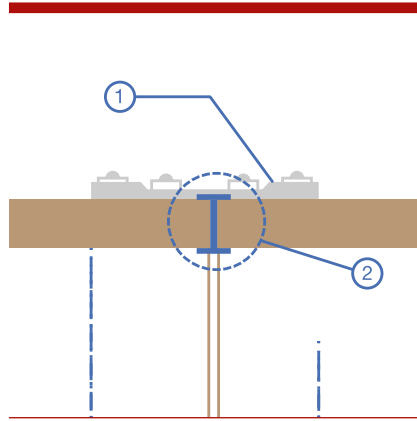

1. Coupling
2. RE-System

RE-SYSTEM

Our COUPLING.Pro and COUPLING.Basic Type 2B in various diameters are supplied with the patented pipe joint identification system (RE-System). The system enables joints made with our flexible couplings to be marked on the inside to prevent misinterpretations in future sewer inspections.

Furthermore, customers can be sure that the flexible coupling they ordered has actually been installed. During assembly of the flexible coupling, the coupling “clip” is placed at the pipe crown between the pipe ends to be connected.



PRODUCT ADVANTAGES

- Unambiguous classification of the joint
- Prevention of unnecessary rehabilitation costs resulting from misinterpretations in future sewer inspections
- Quality assurance: the type of flexible coupling can be checked from the inside
- Easy to install
- No extra costs
- The ID is in the pipe crown, close to the pipe wall
- Resistant to high-pressure flushing

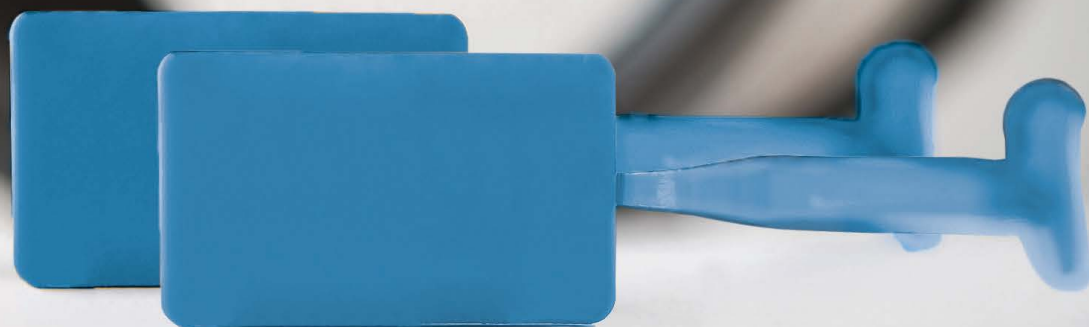

KERA.MAT COUPLING.BASIC, SPECIAL SIZES

TYPE 2B

Clamping Range	Width	Thickness	Tightening Torque
External, d3, mm	mm	mm	
190–215	150	7,7	10
200–225	150	7,7	10
265–290	150	7,7	10
295–320	185	9,2	10
315–345	185	9,2	10
385–410	185	9,2	13
405–430	185	9,2	13
435–465	185	9,2	13
495–525	185	9,2	13
510–540	185	9,2	13
520–550	185	9,2	13
555–580	185	9,2	13
610–640	185	9,2	20
630–660	185	9,2	20
650–680	185	9,2	20
685–715	185	9,2	20
730–760	185	9,2	20
750–780	185	9,2	20
800–830	185	9,2	20
820–850	185	9,2	20
845–875	185	9,2	20
860–890	185	9,2	20
900–930	185	9,2	20
920–950	185	9,2	20
945–975	185	9,2	20
970–999	185	9,2	20
1 000–1 099	185	9,2	20
1 100–1 199	185	9,2	20
1 200–1 299	185	9,2	20



CERAMIC COUPLING DN 200

THE PERFECT CONNECTION

Ideal for a complete system solution and only available from Steinzeug-Keramo. The ceramic coupling is optimized to connect KERA.Base DN 200 normal-strength pipes (strength class 200 and crushing strength FN 40). It is equally suited for connecting spigots in new installations and for retrofitting pipes and fittings. The simple clamping system enables fast, project-compliant assembly.

- Complies with EN 295 for tightness, angular deflection, and shear load Rubber material: EPDM
- Clamp material: stainless steel 1.4301
- Bonding between front face of rubber and sleeve prevents contact between water/subsoil and turnbuckles

CERAMIC SLEEVE

- Length 175 mm
- Internal diameter 270 mm
- External diameter 310 mm

CONNECTING ELEMENTS



CONNECTING ELEMENTS C AND F

for retrofitting connections to:

- Vitrified clay pipes acc. to EN 295
- Vitrified clay jacking pipes acc. to EN 295
- Concrete pipes acc. to EN 1916 and DIN V 1201
- Reinforced-concrete pipes acc. to EN 1916 and DIN V 1201

CONNECTING ELEMENTS C MADE OF VITRIFIED CLAY DN 150 and DN 200

Borehole diameter:
DN 150: 200 ± 1 mm
DN 200: 257 ± 1 mm

CONNECTING ELEMENTS F MADE OF RUBBER ELASTOMER/ABS

Borehole diameter:
DN 125: 152 ± 1 mm
DN 150: 172 ± 1 mm
DN 200: 232 ± 1 mm



You can find the installation instructions for our accessories here.

KERA.MAT CONNECTING ELEMENTS C AND F – USAGE BY PIPE MATERIAL, NOMINAL SIZE AND WALL STRENGTH OF THE VITRIFIED CLAY PIPES ACC. TO EN 295 AND ZP WN 295

Nominal Size	Socket Pipes		
	Connecting Elements*		
DN	DN 125	DN 150	DN 200
200 N	–	–	–
200 H	–	–	–
250 N	F	F	–
250 H	F	F	–
300 N	F	F	–
300 H	F	F	–
350 N	F	F	–
400 N	–	C 40	F
400 H	–	C 40	F
450 H	–	C 40	F
500 N	–	C 40	F
500 H	–	C 40	F
600 N	–	C 40	F
600 H	–	C 40	F
700 H	–	C 70	C 70
800 H	–	C 70	C 70

* The choice of connecting element depends on the actual wall strength at the borehole.

Nominal Size	Jacking Pipes		
	Connecting Elements*		
DN	DN 125	DN 150	DN 200
200	F	F	–
250	F	F	–
300	F	F	F
400	–	C 70	C70
500	–	C 70	C70
600	–	C 70	C70

* The choice of connecting element depends on the actual wall strength at the borehole.

KERA.MAT CONNECTING ELEMENTS CONCRETE PIPES AND OTHER PIPES

Connecting Elements	Wall Thickness
	mm
C 40	40–65
C 70	70–95
C 100	100–115
C 120	120–135
C 140	140–155
C 160	160–175
C 180	180–195
C 200	≥ 200

When using reinforced concrete pipes, make sure that the reinforcement is covered.

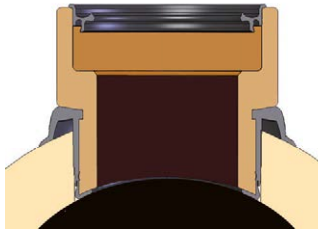

Connecting element C40, DN 150

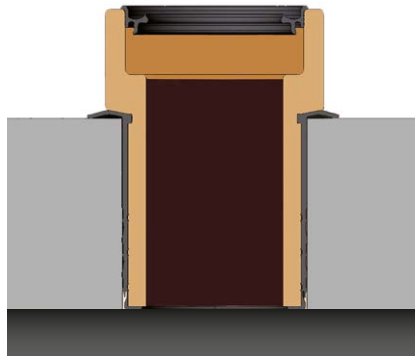

Connecting element C160, DN 150



KERA.Mat Connecting element C

CONNECTING ELEMENT C

Ceramic connecting element.
Full-surface elastomer joint with sealing lips and all-round sealing collar.

DN 150 / DN 200
Connection to medium and large pipes.
Pipe wall thickness 40 mm to 200 mm.
Vitrified clay pipes DN 400 and larger.

CONNECTING ELEMENT F



KERA.MAT Connecting element F

Connecting element comprising ABS compression seal and socket, made of rubber-elastomer.

DN 125 / DN 150 / DN 200
Connection to smaller pipes.
Vitrified clay pipes DN 250 and larger.
Vitrified clay jacking pipes DN 200 and larger.

INSTALLATION INSTRUCTIONS FOR CONNECTING TO VITRIFIED CLAY PIPE SYSTEMS

- According to EN 1610, connections should be made in the upper half of the pipe section, preferably at an angle of 45° from the perpendicular of the longitudinal axis of the pipe.
- The distance to the socket/spigot or between connections must be at least 250 mm.
- Pipes with sufficient length may only be drilled a maximum of twice per pipe. The minimum distance between the boreholes in the longitudinal and transverse axis must be no less than 250 mm.
- When the installation differs from this, the influences on the statics of the pipe and functioning of the pipe system must be checked.



Connecting element in the crown

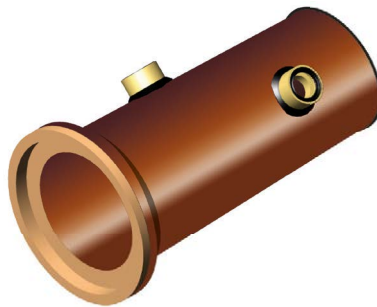

Connecting elements staggered right and left

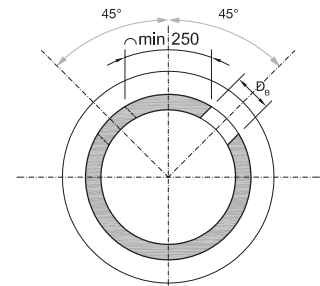

D_B = Diameter of borehole

Cross-section

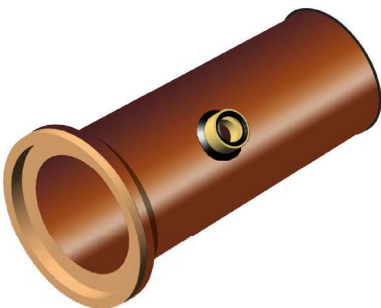

Connecting element right

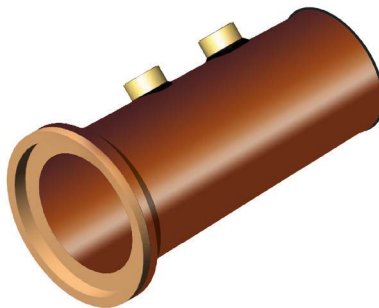

Connecting element left

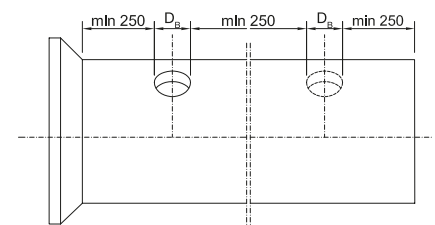

D_B = Diameter of borehole

Lateral view



P-ring C40, DN 150



U-ring C160, DN 150

P-RING

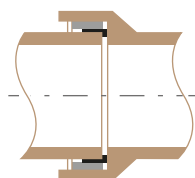

KERA.MAT P-RINGS

P-rings in the DN 200 to DN 600 diameters, in normal-strength and extra-strength versions, are used as jointing elements for the K and S socket-type joints (joint system C) for the spigot of shortened pipes and fittings. They are also used as jointing elements for the transition from spigots, joint system F to socket-type joint K, joint system C.

U-RING

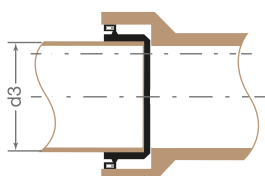

KERA.MAT U-RINGS

For connecting pipes made of other materials to the socket of vitrified clay pipes with socket-type joint L, joint system F. The U-ring is made of rubber-elastomer.

KERA.MAT | JOINTING RINGS | U-RINGS*

Vitrified clay pipe					Vitrified clay pipe Diameter of foreign pipe		
Nominal size	Joint	Joint system	Crushing strength	Strength class	Ductile iron pipe		Plastic pipe
					SML	GGG	PVC-U
DN			FN kN/m	N	d ₃ mm		d ₃ mm
100	L	F	34	–	110 ± 2	–	110 + 0,3/- 0
125	L	F	34	–	135 ± 2	–	125 + 0,3/- 0
150	L	F	34	–	160 ± 2	170 + 1/- 2,9	160 ± 0,4/- 0
200	L	F	40	200	210 ± 2	–	200 + 0,4/- 0

* Special components available on request

DN 150
DN 200 N



BKL jointing element with polystyrene

BKL JOINTING ELEMENT WITH POLYSTYRENE

BKL jointing element (socket joint) for installation in manholes and concrete junctions.

For connecting vitrified clay pipes with joint system F, socket-type joint L. The supporting element is made of polystyrene.

DN 200 N/H
DN 250 N/H
DN 300 N/H
DN 400 N/H
DN 500 N/H
DN 600 N/H



BKL jointing element

BKK JOINTING ELEMENT

BKK jointing element (socket joint) for installation in manholes.

For connecting vitrified clay pipes with joint system C, socket-type joint K/S. The supporting element is made of ABS.



1 | KERA.MAT VITRIFIED CLAY TILES

Format	Number required for 1 m ²	Weight
		Kg/Unit (approx.)
240 x 115 x 20	33	1,25
325 x 115 x 20	24	1,70

The underside is grooved to increase the bonding strength.

2 | KERA.MAT FIXING HOOKS

To secure vitrified clay end caps during the tightness test with air or water. Available in diameters DN 100, DN 125, DN 150, and DN 200. The end cap is inserted with the open side facing outwards and secured with the fixing hook.

3 | KERA.MAT TWO-COMPONENT ADHESIVE SET

For tight bonding of ceramic surfaces Can also be used on wet surfaces.

4 | KERA.MAT LUBRICANT

1 and 3 kg tubs to reduce insertion forces. Suitable for all vitrified clay joint systems acc. to EN 295 and ZP WN 295.

DO YOU ALREADY KNOW OUR NEW CONSTRUCTION SITE SERVICE?

Get to know two new services designed to help you solve many of the day-to-day on-site material problems you face, intelligently and flexibly.



KERA.App

With the KERA.App, you can reorder parts using your smartphone quickly and easily.

You can order any missing accessories directly from the construction site – most of them delivered within 24 hours.



KERA.Box

With the KERA.Box on-site container, our accessories and auxiliary products are available on-site, around the clock.

Go in, get what you need, get back to work. The boxes are preconfigured for each building site, so you get what you really need. We only charge for what you actually take out.



Would you like to use the KERA.Box on your site? Do you have questions about the app? Contact our customer service:

Tel.: +49 2234 507 507

www.steinzeug-keramo.com/kerapp

ATA GLANCE



THE QUALITY OF OUR PRODUCTS AND SERVICES

CERTIFICATIONS

All of our products stand for quality. Quality signifies safety and reliability. Safety and reliability create trust – trust in what we make. We manufacture our pipes and fittings diligently and in full accord with sophisticated technologies – at the very highest level.

Standards for vitrified clay pipes are specified by EN 295, parts 1 to 7. In addition, our products are produced and inspected in compliance with the ZP WN 295 certification program, which in part includes significantly higher requirements than EN 295.

By implementing the standard in areas under the supervision of the building authorities, separate approval of the products is not required by the Deutsche Institut für Bautechnik (DIBt – the German Institute of Construction Engineering).

Our own internal monitoring, voluntary external monitoring and usage rights for various quality labels. For example, the quality labels of the MPA, NRW, Benor, NF and IKOBKB, represent special certification of the quality of our entire product range, and the high standards which go beyond the legal and normative stipulations of the EN 295 European standard.

Most importantly, these labels create trust for the customer, who can rely unreservedly on the assured attributes of our products. At the same time, they document the existence and use of an ISO 9001:2015-compliant quality management system.



CSTB
Centre Scientifique et Technique du Bâtiment,
Marne-la-Vallée (France)



Copro
COPRO is recognized by the Belgian Government as a quality control organization
1731 Zellik (Belgium)



Swiss Quality
Qplus Zertifizierungen,
Zürich (Switzerland)



SKG-IKOB
NL-BSB – Nederlands
(The Netherlands)



MPA NRW
Materialprüfungsamt
North Rhine-Westphalia
(Germany)

STEINZEUG SETS STANDARDS IN MODERN SEWER CONSTRUCTION: ECONOMICAL AND ECOLOGICAL.

Economical FOR PEOPLE

Our products are fair for future generations. The material lasts not just one lifetime, but many. Ongoing costs are minimal, and the durability of our products ensures reliable function even under the heaviest loads, thus guaranteeing maximum operational safety. That relieves the burden on decision makers – financially as well, since it reduces costs in the long term.



4 GOOD REASONS

FOR VITRIFIED CLAY FROM AN ECONOMICAL STANDPOINT

- A service lifetime exceeding 100 years ensures safe, long-term disposal
- Extreme robustness and tightness ensures the function of the wastewater system
- Virtually maintenance-free means reduced budgetary strain spanning decades.
- Natural material saves on renovation costs and disposal expenses if decommissioned.

Ecological FOR THE PLANET

With us, you're making an environmentally sound choice. Our material is 100 percent natural, saves on resources during production, and protects the subsoil during operation. A material with no wear, no microparticles, and no pollutants. At the end of their service life, the pipes can stay in the ground or be recycled as required, thus guaranteeing a completely circular economy.



4 GOOD REASONS

FOR VITRIFIED CLAY FROM AN ECOLOGICAL STANDPOINT

- Vitrified clay consists only of clay, chamotte and water – natural raw materials, nothing else.
- Vitrified clay pipes are 100% recyclable – forever
- Production is climate-neutral – we use local raw materials and power from renewable sources, and our production processes that conserve resources in regions with plentiful water.
- Our production is Cradle-to-Cradle®-certified and in accordance with ESS guidelines
- From nature, for nature – and a clean environment for tomorrow's generations



Proven FOR THE FUTURE

Those who decide today for this forward-looking and environmentally sound solution are making an important contribution to the future of generations to come. We believe we have a responsibility, to make the better world of tomorrow – a real possibility today.

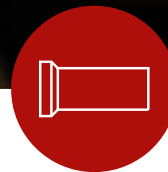

Outstanding

CHARACTERISTICS OF OUR MATERIAL

Specific Weight	22 kN/m ³
Bending Tensile Strength	15 to 40 N/mm ²
Compressive Strength	min. 100 N/mm ²
Tensile Strength	10 to 20 N/mm ²
Young's Modulus	~ 50.000 N/mm ²
Coefficient of Thermal Expansion K ⁻¹	~ 5 x 10 ⁻⁶
Thermal Conductivity	~1,2 W/(mK)
Poisson's Ratio	0,25
Crushing Strength, depending on Nominal Size is from 34 to 160 kN/m	
Tightness	2,4 bar
Corrosion Resistance	resistant
Chemical Resistance.	pH 0 bis 14
Frost Resistance	resistant
Biological Resistance	resistant
Ozone Resistance	resistant
Hardness (Mohs scale)	~ 7
Fatigue Strength	resistant
Fire Resistance	nonflammable
Wall Roughness k	0,02 mm
Abrasion Resistance a _m	≤ 0,25 mm
High-pressure Jetting Resistance	280 bar
Service Lifetime	over 100 years

WE'RE AT YOUR SIDE FOR EVERY PROJECT.

SERVICE & SUPPORT

We are committed to taking care of your needs, working with you at every stage, and supporting you in all matters concerning sewer construction. Our expert employees around the world embody this comprehensive service concept.

- Regional contacts
- Personal construction-site consulting
- Dealer service



Direct and online

INFOPOOL WITH:

- Informational material
- Training sessions/seminars
- Technical documentation
- Model service specifications and online calculator

Register soon at

www.steinzeug-keramo.com

The Infopool offers all relevant calculation modules, CAD drawings of products in our range, and also documents about our pipes, manholes and accessories. You will also find a wealth of information about the proper construction of wastewater installations with vitrified clay pipe systems.

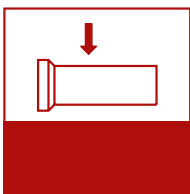

STATICS – OPEN TRENCH

This tool allows you to generate the structural calculation of socket pipes by calculating the required bedding material. You receive a verifiable structural calculation for pipes DN 100 to DN 800.

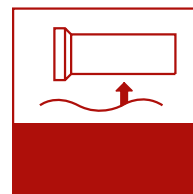

BUOYANCY

Both for vitrified clay manholes and vitrified clay pipes, documentation can be supplied that rules out floating (buoyancy) of the construction.

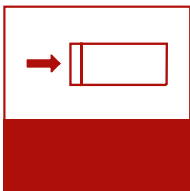

STATICS – TRENCHLESS

This tool allows you to generate the structural calculation for jacking pipes by calculating the permissible jacking forces. You receive a verifiable structural calculation for pipes DN 150 to DN 600

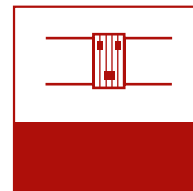

COUPLING

For connecting spigots, the Coupling Calculator works out the type of coupling and, if necessary, the quantity and type of compensating rings required.

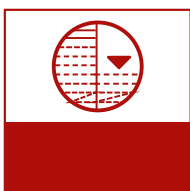

HYDRAULIC

This program offers a simple method to calculate the outflow in round sections. The flow rate, gradient and flow velocity can be calculated for Steinzeug-Keramo products under full and partial filling conditions.

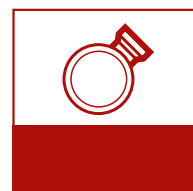

CONNECTING ELEMENT

This calculator allows you to calculate the type of connecting element to use with retrofitted connections, both with vitrified clay pipes and pipes made of other materials (concrete).

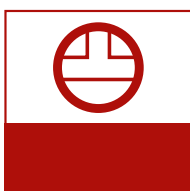

MANHOLE

Vitrified clay manholes DN 600 to DN 1000 can be assembled and calculated.



COST-EFFECTIVENESS

This program is designed to demonstrate the economic performance of vitrified clay pipe systems compared with systems made of other materials.



ENVIRONMENTAL PROTECTION & SUSTAINABILITY

RESPONSIBILITY IN EVERYDAY PRACTICE

With their outstanding technical, chemical and physical characteristics, vitrified clay pipes fulfill all environmental demands. They unite the greatest strength, impermeability and hardness with excellent abrasion and corrosion resistance. In addition, their long service life coupled with low maintenance and repair requirements makes them a cost-effective long-term solution.

We want to help communities become climate-neutral as soon as possible, and to move ahead with us into a CO₂-neutral future.

OUR PROMISE

- to increase the benefits for our partners with economically and environmentally sound characteristics
- not to compromise the health of people who come into contact with our products
- to take both economic and environmental needs into account in equal measure

*100% nature.
Zero waste.*

RAW MATERIAL EXTRACTION

We mine the clay for our products locally. This allows environmentally sound raw material extraction and subsequent ecological restoration.

RAW MATERIAL TRANSPORT

By sourcing raw materials close to our regional factories, our production processes conserve resources and are low in CO₂ output.

RECYCLING

Ceramic products are 100% recyclable, returning to the production cycle as the material chamotte.



OPERATION

With their long service lifetime and low service and maintenance costs, our products offer long-term economic viability.



INSTALLATION

We offer pipe systems for both open-trench and trenchless construction, with on-site technical expertise.

LOGISTICS

Sophisticated logistics and freight optimization protect the environment. Flexible and fast – short routes to trade dealers or straight to the construction site.

RAW MATERIAL

Clay, chamotte and water. Only these natural raw materials go into our sustainable products.



MANUFACTURING PROCESS

Cradle to Cradle® criteria are observed throughout the manufacturing process and optimized with biomass systems, heat exchangers and green power.



CRADLE TO CRADLE®

A PRODUCT CYCLE WITH A FUTURE

Cradle to Cradle® means everything planned so that no waste is generated. Each component continues its service, becoming a raw material for another new product in a system that profits industry, the economy and consumers alike.



MATERIAL

No raw material is used untested. We know the exact composition, durability and environmental compatibility of everything we use. All our raw materials come from nearby clay pits and are environmentally harmless.



WATER

We treat this valuable resource with the greatest care throughout our production processes. All of our production facilities for example, are in regions with plentiful water.

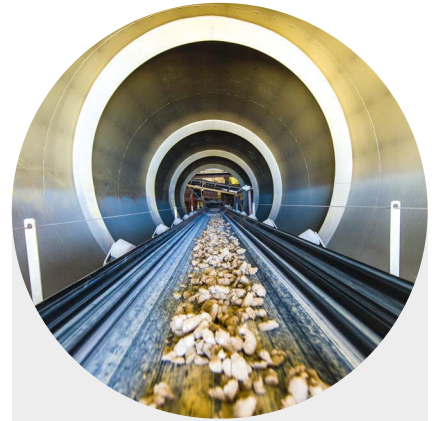

RECYCLING

Ceramic products are 100% recyclable, returning to the production cycle as the material chamotte. Pipes can also remain in the ground without causing problems.



We have been living these rules not only since we achieved Cradle to Cradle® certification, but since we first started producing pipes and fittings from vitrified clay.

*For us,
sustainability means
looking centuries ahead.*



ENERGY

We are constantly optimizing our energy consumption by using fast-firing technology, heat recovery with heat exchangers, and energy from regional biogas facilities. In addition, we use green power from renewable sources and primarily work with local resources. We produce in Europe for Europe – keeping transport routes as short as possible.



SOCIAL RESPONSIBILITY

We see our employees as responsible people and we make every effort to support them in this role. Work safety, work-life balance, skill enhancements and career planning are core policies. We cultivate respectful and honest interactions with our suppliers, customers, and colleagues alike.

CLIMATE-NEUTRAL PRODUCTION

OUR RESPONSIBILITY FOR THE FUTURE

Inspired by Nature

Climate protection is one of the greatest challenges of our time. To safeguard our future, we need to reduce greenhouse gas emissions and energy consumption, and make more efficient use of renewable energy sources. Many towns and cities are aware of their share of responsibility for this issue, and are leading the way by adopting green public procurement strategies. As a supplier of wastewater systems, we have also committed ourselves to an environmentally friendly product portfolio.

OUR CONTRIBUTION TO ENVIRONMENTAL AND CLIMATE PROTECTION

As a supplier of vitrified clay wastewater systems, we are committed to products made of 100% natural raw materials. We have been dedicated to sustainability and effective environmental protection for years.

The successful Cradle to Cradle® certification motivates us to invest more in climate and environmental protection.

We have the know-how to effectively reduce CO₂ emissions with our products. With our carbon-neutral vitrified clay pipes, we are already making a decisive contribution to effective climate and environmental protection. In addition, we actively support sewerage operators in their quest to be ecologically better and offer real “green” alternatives for future-proof and environmentally-aware material procurement.



You can find out more on
this topic on our website:
www.steinzeug-keramo.com

$$\text{SUS TAIN ABILITY} \uparrow = \frac{\uparrow \text{SERVICE LIFE}}{\downarrow \text{IMPACTS ON THE ENVIRONMENT}}$$

GET TO KNOW OUR SOLUTION FOR PROFESSIONAL SEWER REHABILITATION



THE DURA RANGE PROFESSIONAL REHABILITATION AND CONSTRUCTION

THE ALL-ROUND SOLUTION FOR
ACCESSIBLE SEWER SYSTEMS



SEWER
REHABILITATION
PARTIAL OR
COMPLETE.



NEW SEWER
CONSTRUCTION.
RETROACTIVELY
OPTIMIZED.



MANHOLE
REHABILITATION.
SYSTEMATICALLY
REFURBISHED.



Find out more about our
DURA range on our website
or directly, with the AR-code:

www.steinzeug-keramo.com

NOTES

.....

.....

.....

.....

.....

.....

.....

.....

.....

.....

.....

.....

.....

.....

.....

.....

.....

STAY INFORMED

FOLLOW US ON



Steinzeug-Keramo GmbH

Europaallee 63 | D-50226 Frechen

Telephone +49 2234 507-0
Telefax +49 2234 507-207

Email info@steinzeug-keramo.com
Internet www.steinzeug-keramo.com

Steinzeug-Keramo N.V.

Paalsteenstraat 36 | B-3500 Hasselt

Telephone +32 11 21 02 32
Telefax +32 11 21 09 44

Email info@steinzeug-keramo.com
Internet www.steinzeug-keramo.com